

IEC Appliance Inlet C20 with Line Switch, 2-pole



Screw-on mounting
 from front side
 non-illuminated, black



Snap-in mounting from front side
 illuminated version



See below:
[Approvals and Compliances](#)

Description

- Panel mount :
 Screw-on version from front or rear side, snap-in version front side
- 2 Functions :
 Appliance Inlet Protection class I , Line Switch 2-pole
- Quick connect terminals 6.3 x 0.8 mm

Characteristics

- All single elements are already wired
- Unwired versions available on request
- Line switch non-illuminated or illuminated
- Ideal for application with high transient loads
- Suitable for use in equipment according to IEC/UL 62368-1

Other versions on request

- Unwired versions
- Line switch with other rocker marking
- For protection class II
- Variant with notch for V-Lock mating Cordsets

References

Alternative: version with line filter [EC12](#)

Weblinks

[pdf data sheet](#), [html datasheet](#), [General Product Information](#), [Approvals](#), [Distributor-Stock-Check](#), [Accessories](#), [Detailed request for product](#)

Newly available variants corresponding to V-Lock mating cordset. The connector is equipped with a notch intended for use with the latching cordset. The cord latching system prevents against accidental removal of the cordset.

Technical Data

Ratings IEC	16A / 250VAC; 50Hz	Appliance inlet/-outlet	C20 acc. to IEC 60320-1, UL 60320-1, CSA C22.2 no. 60320-1 (for cold conditions) pin-temperature 70 °C, 16A, Protection Class I
Ratings UL/CSA	20A / 250VAC; 60Hz	Line Switch	Rocker switch 2-pole, non-illuminated or illuminated, acc. to IEC 61058-1 Technical Details
Dielectric Strength	> 2.5kVAC between L-N > 3kVAC between L/N-PE (1 min/50Hz)		
Allowable Operation Temperature	-25 °C to 70 °C		
IP-Protection	front side IP40 acc. to IEC 60529		
Protection against electric shock	Suitable for appliances with protection class I acc. to IEC 61140		
Terminal	Quick connect terminals 6.3 x 0.8 mm		
Panel Thickness S	Screw: max 8 mm Mounting screw torque max 0.5Nm Snap-in: 1.5/2/2.5 mm		
Material: Housing	Thermoplastic, black, UL 94V-0		

Approvals and Compliances



Detailed information on product approvals, code requirements, usage instructions and detailed test conditions can be looked up in [Details about Approvals](#)

SCHURTER products are designed for use in industrial environments. They have approvals from independent testing bodies according to national and international standards. Products with specific characteristics and requirements such as required in the automotive sector according to IATF 16949, medical technology according to ISO 13485 or in the aerospace industry can be offered exclusively with customer-specific, individual agreements by SCHURTER.

Approvals





The approval mark is used by the testing authorities to certify compliance with the safety requirements placed on electronic products.

Approval Reference Type: EC11

Approval Logo	Certificates	Certification Body	Description
	VDE Approvals	VDE	Certificate Number: 40001031
	UL Approvals	UL	UR File Number: E96454
	CCC Approvals	CCC	CCC Certificate Number: 2014010204683955

Product standards

Product standards that are referenced

Organization	Design	Standard	Description
	Designed according to	IEC 60320-1	Appliance couplers for household and similar general purposes
	Designed according to	IEC 61058-1	Switches for appliances. Part 1. General requirements
	Designed according to	UL 60320-1	Standard for Attachment Plugs and Receptacles
	Designed according to	CSA C22.2 no. 60320-1	General Use Receptacles, Attachment Plugs, and Similar Wiring Devices







Application standards

Application standards where the product can be used

Organization	Design	Standard	Description
	Suitable for applications acc.	IEC/UL 62368-1	Audio/video, information and communication technology equipment - Part 1: Safety requirements
	Suitable for applications acc.	IEC 60335-1	Safety of electrical appliances for household and similar purposes. Meets the requirements for appliances in unattended use. This includes the enhanced requirements of glow wire tests acc. to IEC 60695-2-11 or -12 & -13.

Compliances

The product complies with following Guide Lines

Identification	Details	Initiator	Description
	CE declaration of conformity	SCHURTER AG	The CE marking declares that the product complies with the applicable requirements laid down in the harmonisation of Community legislation on its affixing in accordance with EU Regulation 765/2008.
	UKCA declaration of conformity	SCHURTER AG	The UKCA marking declares that the product complies with the applicable requirements laid down in the British Amendment of Regulation (EC) 765/2008.
	RoHS	SCHURTER AG	Directive RoHS 2011/65/EU, Amendment (EU) 2015/863
	China RoHS	SCHURTER AG	The law SJ / T 11363-2006 (China RoHS) has been in force since 1 March 2007. It is similar to the EU directive RoHS.
	REACH	SCHURTER AG	On 1 June 2007, Regulation (EC) No 1907/2006 on the Registration, Evaluation, Authorization and Restriction of Chemicals 1 (abbreviated as "REACH") entered into force.
		SCHURTER AG	V-Lock system are based on a matching plug-dose combination. The connector is equipped with a notch intended for use with the latching cordset. The cord latching system prevents against accidental removal of the cordset.
	White Paper Glow wire test	SCHURTER AG	Meets the requirements of IEC 60335-1 for appliances in unattended use. This includes the enhanced requirements of glow wire tests acc. to IEC 60695-2-11 or -12 & -13.

Dimensions [mm]

Screw-on mounting

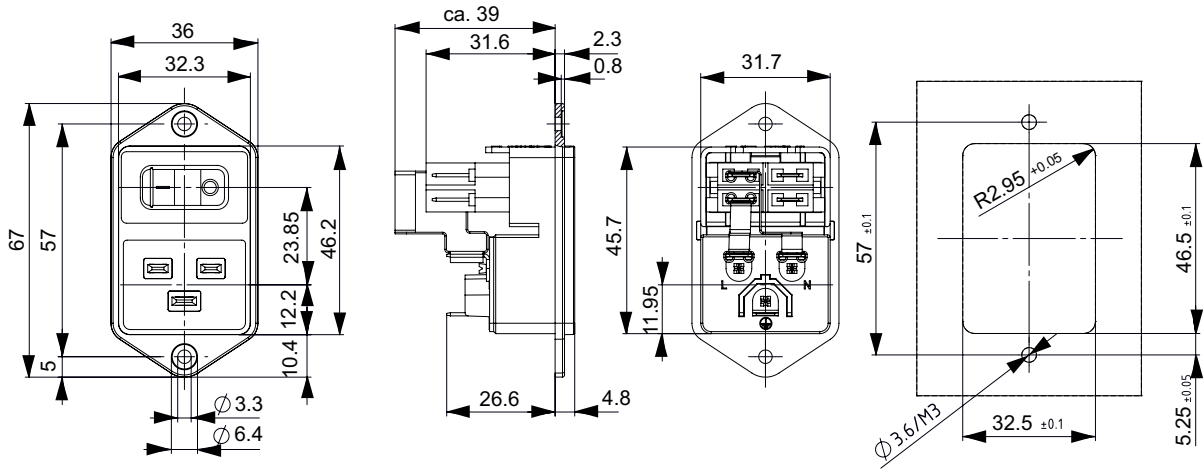

Snap-in mounting

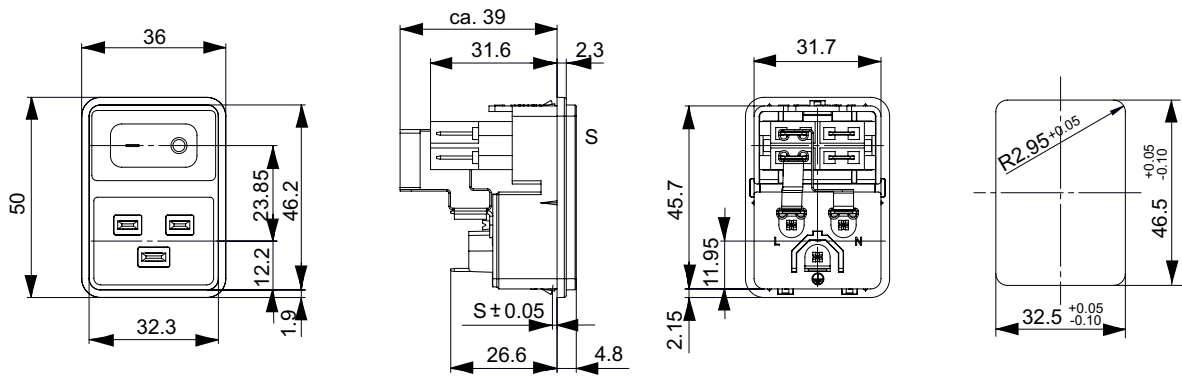

Diagrams

Line switch non-illuminated

Line switch illuminated

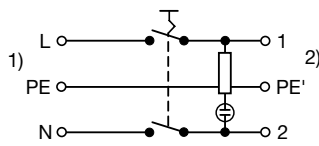
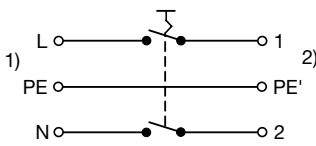

1) Line
2) Load

1) Line
2) Load

Variants

Panel mounting	Panel Thickness s [mm]	Illumination	Color	Internally wired	V-Lock	Order Number
Snap-in	1.5	-	-	●	-	EC11.0001.201
Snap-in	1.5	-	-	●	●	EC11.0001.201.21
Snap-in	1.5	-	-	-	-	EC11.0001.202
Snap-in	1.5	●	red	●	-	EC11.0021.201
Snap-in	1.5	●	red	●	●	EC11.0021.201.21

Panel mounting	Panel Thickness s [mm]	Illumination	Color	Internally wired	V-Lock	Order Number
Snap-in	1.5	●	red			EC11.0021.202
Snap-in	1.5	●	green	●		EC11.0031.201
Snap-in	1.5	●	green	●	●	EC11.0031.201.21
Snap-in	1.5	●	green			EC11.0031.202
Snap-in	2		-	●		EC11.0001.301
Snap-in	2		-	●	●	EC11.0001.301.21
Snap-in	2		-			EC11.0001.302
Snap-in	2	●	red	●		EC11.0021.301
Snap-in	2	●	red	●	●	EC11.0021.301.21
Snap-in	2	●	red			EC11.0021.302
Snap-in	2	●	green	●		EC11.0031.301
Snap-in	2	●	green	●	●	EC11.0031.301.21
Snap-in	2	●	green			EC11.0031.302
Snap-in	2.5		-	●		EC11.0001.401
Snap-in	2.5		-			EC11.0001.402
Snap-in	2.5	●	red	●		EC11.0021.401
Snap-in	2.5	●	red			EC11.0021.402
Snap-in	2.5	●	green	●		EC11.0031.401
Snap-in	2.5	●	green			EC11.0031.402
Screw	-		-	●		EC11.0001.001
Screw	-		-	●	●	EC11.0001.001.21
Screw	-		-			EC11.0001.002
Screw	-	●	red	●		EC11.0021.001
Screw	-	●	red	●	●	EC11.0021.001.21
Screw	-	●	red			EC11.0021.002
Screw	-	●	green	●		EC11.0031.001
Screw	-	●	green	●	●	EC11.0031.001.21
Screw	-	●	green			EC11.0031.002

Availability for all products can be searched real-time: <https://www.schurter.com/en/info-center/support-tools/stock-check-distributors>

Packaging unit

25 Pcs

Accessories

Description



[Wire_Harness](#)
 Wire harness for SCHURTER products



[RC320](#)
 Rear Cover for Power Entry Module



[Cord_retaining_kits](#)
 Cord retaining strain relief

Flat head, H	4700.0008
--------------	-----------

Mating Outlets/Connectors

Category / Description



[Connector Overview complete](#)

4795, Mounting: Power Cord, Cable Connector: IEC C19	4795
4790, Mounting: Power Cord, Screw Connector: IEC C19	4790
0104U, Mounting: Power Supply Cord, Screw clamps Connector: IEC C19	0104U

[Power Supply Cord Overview complete](#)



Cord Sets 10 A, North America, 3.0 m, Connector IEC C13, SJT 3x18 AWG, transparent	4300.0920
Cord Sets 16 A, Europlug, 2.5 m, Connector IEC C19, H05VV-F3G1.5, black	6004.0395
Cord Sets 16 A, Interconnection, 1.0 m, Connector IEC C19, H05VV-F3G1.5, black	6020.0392
Cord Sets 16 A, Interconnection, 2.0 m, Connector IEC C19, H05VV-F3G1.5, black	6020.0394
Cord Sets 16 A, North America, 2.5 m, Connector IEC C19, SJT 3x14 AWG, black	6009.5195

Mating Outlets/Connectors shuttered



[Connector Overview complete](#)

4799, Mounting: Power Cord, Cable Connector: IEC C19	4799
--	------



Power Cord Overview complete

VAC19KS, Overview, V-Lock cord retaining, diverse Connector IEC C19, diverse, black

VAC19KS