

Membrane Switch Frontpanel Short Stroke 18 mm



Membrane Switch Frontpanel Short Stroke 18 mm  
 square  
 White, lettered



Membrane Switch Frontpanel Short Stroke 18 mm  
 round  
 red, lettered



Membrane Switch Frontpanel Short Stroke 18 mm  
 round  
 green

See below:

**Approvals and Compliances**

**Description**

- Momentary action switch available in version square or round in different colours
- High lifetime with 5 million actuations
- Front and rear tested to degree of protection IP65 Snap-in type from front side
- Solder terminals

**Unique Selling Proposition**

- Unique mechanical switches with tactile feedback
- Small mounting depth
- Various lettering options

**Technical Data**

**Electrical Data**

Impulse Withstand Voltage (ESD)  $\pm 16$  kV

**Contact Material Silver**

Switching Voltage min. 5 VDC, max. 48 VDC

Switching current max. 125 mA

Rated Switching Capacity 0.72 W

Lifetime > 1 million actuations at Rated Switching Capacity

Contact Resistance < 50 m $\Omega$   
 < 150 m $\Omega$  after lifetime

Insulation Resistance > 100 M $\Omega$   
 Duration of Bounce typ. 0.1 ms

**Contact Material Gold**

Switching Voltage min. 50 mVDC, max. 24 VDC

Switching current max. 80 mA

Rated Switching Capacity 0.36 W

Lifetime > 1 million actuations at Rated Switching Capacity

Contact Resistance < 50 m $\Omega$   
 < 150 m $\Omega$  after lifetime

Insulation Resistance > 100 M $\Omega$   
 Duration of Bounce typ. 0.1 ms

**Weblinks**

[pdf data sheet](#), [html datasheet](#), [General Product Information](#), [CAD-Drawings](#), [Product News](#), [Detailed request for product](#)

**Mechanical Data**

Actuating Force  $3 \pm 1$  N

Actuating Travel  $0.5 \pm 0.1$  mm

End Stop Strength > 50 N

Lifetime > 1 million actuations

Mounting screw torque 8N/cm

**Climatical Data**

Operating Temperature -25 °C to 60 °C

Storage Temperature -25 °C to 60 °C

IP-Protection IP65 (only with accessory kit)

**Other Data**

Contact Material Ag / Au

**Soldering Data**

Solderability 235 °C / 2 sec (IEC 60068-2-20 Test Ta Method 1)

Resistance to Soldering Heat 260 °C / 5 sec (IEC 60068-2-20 Test Tb Method 1A)

**Material**

Housing Thermoplastic (PES)

Socket Thermoplastic (PES)

Bezel Thermoplastic (PBT)

Contact CuZn37 3  $\mu$ m Ni 2  $\mu$ m Au; CuZn37 2.5  $\mu$ m Ag

Soldering Aid Tin-plated

**Approvals and Compliances**

Detailed information on product approvals, code requirements, usage instructions and detailed test conditions can be looked up in [Details about Approvals](#)

SCHURTER products are designed for use in industrial environments. They have approvals from independent testing bodies according to national and international standards. Products with specific characteristics and requirements such as required in the automotive sector according to IATF 16949, medical technology according to ISO 13485 or in the aerospace industry can be offered exclusively with customer-specific, individual agreements by SCHURTER.



## Application standards

Application standards where the product can be used

| Organization   | Design                         | Standard       | Description   |
|--|--------------------------------|----------------|---|
|  | Suitable for applications acc. | IEC/UL 62368-1 | Audio/video, information and communication technology equipment - Part 1: Safety requirements |

## Compliances

The product complies with following Guide Lines

| Identification   | Details    | Initiator   | Description   |
|--|------------|-------------|---|
|  | RoHS       | SCHURTER AG | Directive RoHS 2011/65/EU, Amendment (EU) 2015/863  |
|  | China RoHS | SCHURTER AG | The law SJ / T 11363-2006 (China RoHS) has been in force since 1 March 2007. It is similar to the EU directive RoHS.  |
|  | REACH      | SCHURTER AG | On 1 June 2007, Regulation (EC) No 1907/2006 on the Registration, Evaluation, Authorization and Restriction of Chemicals 1 (abbreviated as "REACH") entered into force. |

## Dimension [mm]

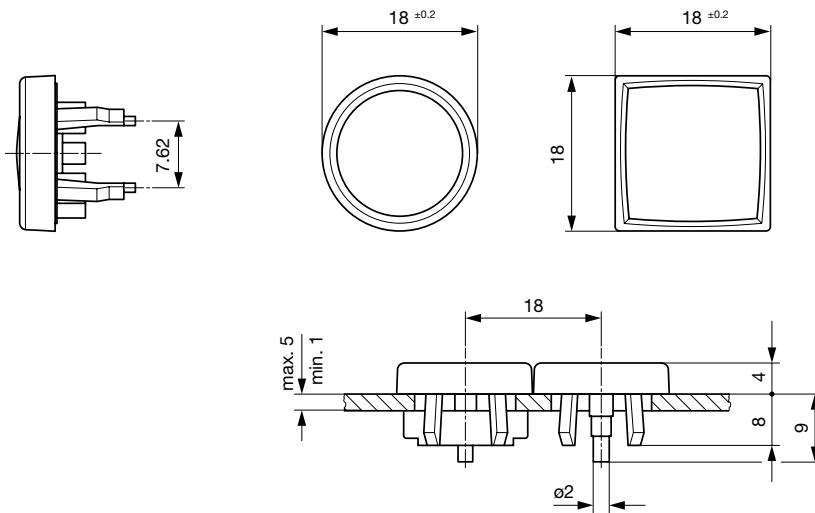

## Dimension

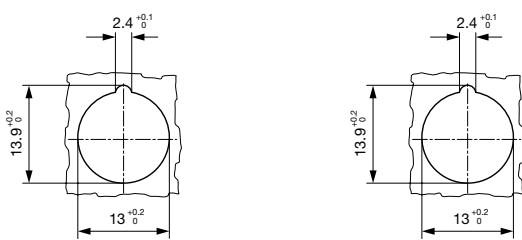

Drilling diagram

Drilling diagram

## Assembly Instructions

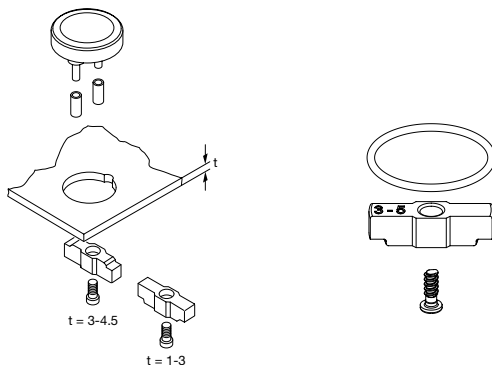

Accessory kit IP65 has to be ordered separately

## Diagrams



## Order Index Lettering

Laser Marking

|        |        |             |             |
|--------|--------|-------------|-------------|
| 001 =A | 021 =U | 041 =÷      | 061 =EIN    |
| 002 =B | 022 =V | 042 =*      | 062 =AUS    |
| 003 =C | 023 =W | 043 ==      | 063 =AUF    |
| 004 =D | 024 =X | 044 =#      | 064 =AB     |
| 005 =E | 025 =Y | 045 =↔      | 065 =ON     |
| 006 =F | 026 =Z | 046 =‡      | 066 =OFF    |
| 007 =G | 027 =0 | 047 =→      | 067 =UP     |
| 008 =H | 028 =1 | 048 =←      | 068 =DOWN   |
| 009 =I | 029 =2 | 049 =↓      | 069 =HIGH   |
| 010 =J | 030 =3 | 050 =↑      | 070 =LOW    |
| 011 =K | 031 =4 | 051 =%      | 071 =ON/OFF |
| 012 =L | 032 =5 | 052 =√      | 072 =START  |
| 013 =M | 033 =6 | 053 =CTRL   | 073 =RESET  |
| 014 =N | 034 =7 | 054 =RETURN | 074 =⏻      |
| 015 =O | 035 =8 | 055 =SHIFT  | 075 =⚙️     |
| 016 =P | 036 =9 | 056 =LOCK   | 076 =🔒      |
| 017 =Q | 037 =+ | 057 =STOP   | 077 =Ⓜ️     |
| 018 =R | 038 =- | 058 =ENTER  |             |
| 019 =S | 039 =. | 059 =BACK   |             |
| 020 =T | 040 =x | 060 =LINE   |             |











Please note that the font size depends on the number of characters

## Letter heights and Fonts

- Single characters, Univers 65
- Legends max. 6 characters in line, Univers 65
- Insert label and front foil anthracite, RAO 7016
- Characters and symbols light grey, RAL 7035

## Order number key

|   |   |   |    |   |   |   |    |   |    |   |     |   |    |   |   |   |   |   |    |   |    |
|---|---|---|----|---|---|---|----|---|----|---|-----|---|----|---|---|---|---|---|----|---|----|
| M | C | S | 18 | - | A | - | BK | - | GN | - | 038 | - | AG | - | S | - | P | - | 00 | - | S  |
|   |   |   | 1  |   | 2 |   | 3  |   | 4  |   | 5   |   | 6  |   | 7 |   | 8 |   | 9  |   | 10 |

|  |   |  |   |           |
|--|---|--|---|-----------|
| <b>Diameter</b>                          |   |  |    | <b>1</b>  |
| 18 mm                                    | = |  |   | 18        |
| <b>Housing shape</b>                     |   |  |    | <b>2</b>  |
| Round                                    | = |  |   | A         |
| Square                                   | = |  |   | B         |
| <b>Bezel color</b>                       |   |  |    | <b>3</b>  |
| Black                                    | = |  |   | BK        |
| White                                    | = |  |   | WT        |
| Grey                                     | = |  |   | GY        |
| Yellow                                   | = |  |   | YL        |
| Green                                    | = |  |   | GN        |
| Red                                      | = |  |   | RD        |
| Orange                                   | = |  |   | OR        |
| Blue                                     | = |  |   | BL        |
| <b>Actuator color</b>                    |   |  |    | <b>4</b>  |
| Black                                    | = |  |   | BK        |
| White                                    | = |  |   | WT        |
| Grey                                     | = |  |   | GY        |
| Yellow                                   | = |  |   | YL        |
| Green                                    | = |  |   | GN        |
| Red                                      | = |  |   | RD        |
| Orange                                   | = |  |   | OR        |
| Blue                                     | = |  |   | BL        |
| Anthracite                               | = |  |   | AN        |
| <b>Marking type</b>                      |   |  |  | <b>5</b>  |
| Customer spec.                           | = |  |   | CCC       |
| None                                     | = |  |   | 000       |
| Standard symbols                         | = |  |   | 001-077   |
| See in the table "Order Index Lettering" |   |  |   |           |
| <b>Contact material</b>                  |   |  |  | <b>6</b>  |
| Silver                                   | = |  |   | AG        |
| Gold                                     | = |  |   | AU        |
| <b>Mounting</b>                          |   |  |  | <b>7</b>  |
| Print                                    | = |  |   | P         |
| Snap-in (1.0-5.0 mm)                     | = |  |   | S         |
| <b>Terminal switch</b>                   |   |  |  | <b>8</b>  |
| Pin                                      | = |  |   | P         |
| Solder                                   | = |  |   | S         |
| <b>Accessories</b>                       |   |  |  | <b>9</b>  |
| None                                     | = |  |   | 00        |
| IP65 kit                                 | = |  |   | IP        |
| <b>Execution Type</b>                    |   |  |  | <b>10</b> |
| Standard                                 | = |  |   | S         |
| Customized                               | = |  |   | C         |

**Variants**

| Kontakte           | Form                     | Color Bezel | Color Touchpad | Marking           | Bestellnummer  |
|--------------------|--------------------------|-------------|----------------|-------------------|----------------|
| Ag                 | round                    | white       | white          | without Lettering | 1241.1104.8098 |
| Ag                 | square                   | black       | red            | without Lettering | 1241.1100.7093 |
| Ag                 | square                   | black       | green          | without Lettering | 1241.1100.7095 |
| Ag                 | square                   | black       | black          | without Lettering | 1241.1100.7097 |
| Ag                 | round                    | black       | yellow         | without Lettering | 1241.1104.7091 |
| Ag                 | round                    | black       | red            | without Lettering | 1241.1104.7093 |
| Ag                 | round                    | black       | green          | without Lettering | 1241.1104.7095 |
| Ag                 | round                    | black       | grey           | without Lettering | 1241.1104.7096 |
| Ag                 | round                    | black       | black          | without Lettering | 1241.1104.7097 |
| Ag                 | round with soldering aid | black       | black          | without Lettering | 1241.1113.7097 |
| Accessory kit IP65 | -                        | -           | -              | -                 | 0098.9201      |

For Lettering versions see tables "Lettering" and "Order Index Lettering" to determine the symbol

Availability for all products can be searched real-time: <https://www.schurter.com/en/info-center/support-tools/stock-check-distributors>

**Packaging unit** 100 pcs