

Touchless Switch



Illuminated green



Non-illuminated

**Description**

- Touchless Momentary (MO) push button
- Multicolor illumination
- Standard sensitivity for glass thickness of up to 2mm
- Quick and easy installation behind all materials (glass, plastic, wood, metal,...). There must be a small viewing window for the sensor.

**Unique Selling Proposition**

- Allows free design
- Invisible installation
- Small mounting depth

See below:

**Approvals and Compliances**

**Characteristics**

- Insensitive to water and rain
- Area illumination
- Wearless, no moving parts
- Wiping tolerant
- 3M Adhesive transfer tape 468MP

**Other versions on request**

- Design-In-Kit
- Switching type latching

**Weblinks**

[pdf data sheet](#), [html datasheet](#), [General Product Information](#), [CAD-Drawings](#), [Product News](#), [Detailed request for product](#)

**Technical Data**

**Electrical Data**

Switching Voltage	max. 42 VAC/ 60 VDC
Switching current	max. 100 mA
Switch Resistance OFF	> 10 MΩ
Switch Resistance ON	< 16 Ω
Supply Voltage	5 - 28 VDC
Current Consumption all LEDs	adjustable by the customer
Reverse Polarity Protection	Yes
Short Circuit Protection	Yes
Output	OptoMOS Relais
Lifetime	> 100 million actuations

**Mechanical Data**

Actuation Type	optical
Actuating Force	none

**Climatical Data**

Operating Temperature	-40 to 85 °C
Storage Temperature	-40 to 85 °C

**Approvals and Compliances**

Detailed information on product approvals, code requirements, usage instructions and detailed test conditions can be looked up in [Details about Approvals](#)

SCHURTER products are designed for use in industrial environments. They have approvals from independent testing bodies according to national and international standards. Products with specific characteristics and requirements such as required in the automotive sector according to IATF 16949, medical technology according to ISO 13485 or in the aerospace industry can be offered exclusively with customer-specific, individual agreements by SCHURTER.

**Compliances**

The product complies with following Guide Lines

Identification	Details	Initiator	Description
	<a href="#">CE declaration of conformity</a>	SCHURTER AG	The CE marking declares that the product complies with the applicable requirements laid down in the harmonisation of Community legislation on its affixing in accordance with EU Regulation 765/2008.
	<a href="#">UKCA declaration of conformity</a>	SCHURTER AG	The UKCA marking declares that the product complies with the applicable requirements laid down in the British Amendment of Regulation (EC) 765/2008.
	RoHS	SCHURTER AG	Directive RoHS 2011/65/EU, Amendment (EU) 2015/863
	REACH	SCHURTER AG	On 1 June 2007, Regulation (EC) No 1907/2006 on the Registration, Evaluation, Authorization and Restriction of Chemicals 1 (abbreviated as "REACH") entered into force.

Dimension [mm]

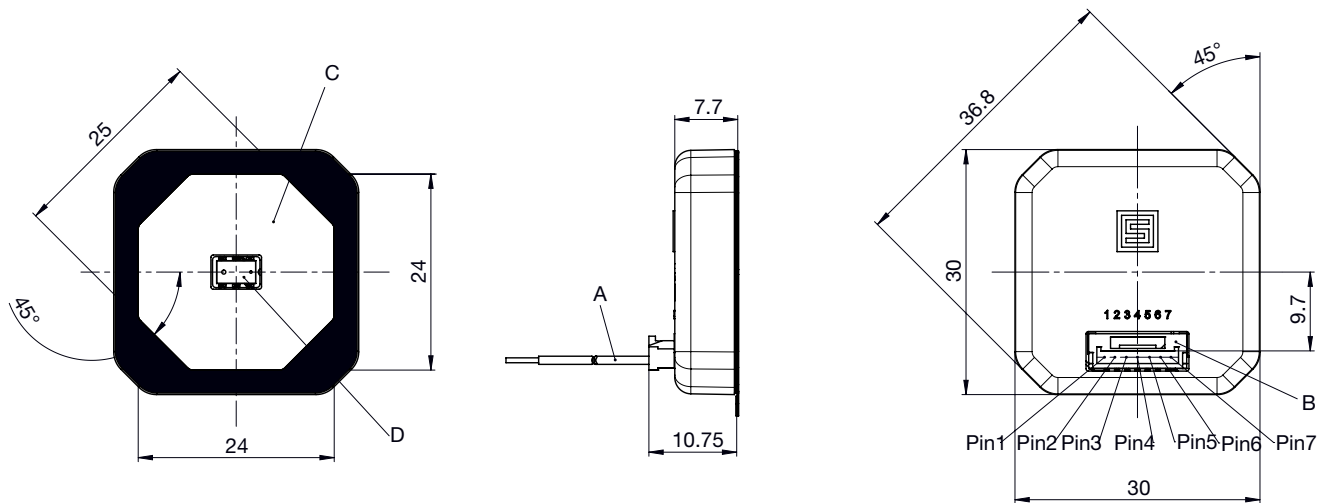

- A: Stranded
- B: Suitable for connector JST GHR-07V-S
- C: Illumination area
- D: Viewing window of the sensor LxW (mm) 6.2x4.2

Diagrams

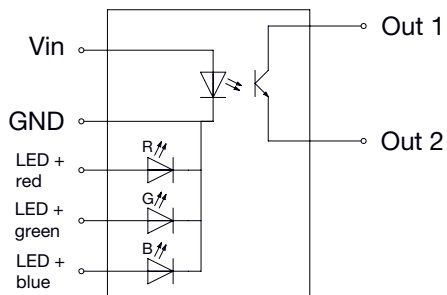

Depending on the selected supply voltage (5 - 28 VDC) the series resistors for the LEDs have to be selected (max. 20 mA rated current)

Connection assignment

PIN-number	Wire color	function
1	brown BN	Vin = 5 VDC...28 VDC
2	black BK	GND
3	white WT	Out 1
4	white WT	Out 2
5	red RD	LED red
6	green GN	LED green
7	blue BL	LED blue

Design-In-Kit



Development tool for special settings of THS

**Area illumination**

Operating Data	Forward Voltage	Nominal LED current
<b>LED red</b>	2.1 V	20 mA
<b>LED green</b>	3.0 V	20 mA
<b>LED blue</b>	3.1 V	20 mA
PWM frequency LED: max. 100Hz		
Power consumption without lighting: < 1mA	(Output contact open)	
Power consumption without lighting: < 6mA	(Output contact closed)	

Order number key

T	H	S	-	3	0	-	M	O	N	O	A	1	0	C	0	-	A	I	R	G	B	0	0	R	C	0	-	P	4	P	1	-	P	-	0	6	G	0	2	0
				1			2		3		4		5				6		7		8		9					10		11		12				13		14		15

\* Please note that only the configuration below are available by default.  
 Other configurations on request

**Dimensions** L x B x H [mm]  **1**  
 THS = 30 x 30 x 10.78

**Switching type**  **2**  
 Push button = MO

**Switch function**  **3**  
 Normally open = NO

**Rated current**  **4**  
 100mA = A10

**Terminal switch**  **5**  
 Connector integrated = C0

**Illumination type**  **6**  
 Area illumination = AI

**Illumination color**  **7**  
 Multicolor = RGB

**Supply voltage illumination**  **8**  
 w/o resistor = 00R

**Terminal illumination**  **9**  
 Connector integrated = C0

**Housing material**  **10**  
 Lexan Resin EXL9330 = P4

**Actuator material**  **11**  
 PMMA = P1

**Mounting**  **12**  
 Adhesive = P

**Detection distance**  **13**  
 6 cm = 06

**Front panel material**  **14**  
 Float glass = G0

**Front panel thickness**  **15**  
 2mm = 20

### Variants

Designation	Rated current	Illumination	Switching Voltage	Config. Code	Order Number
THS	100 mA	Area illumination	42 VAC / 60 VDC	THS-30-MONOA10C0-AIRGB00RC0-P4P1-P-06G020	3-140-093

Availability for all products can be searched real-time: <https://www.schurter.com/en/info-center/support-tools/stock-check-distributors>

### Packaging unit

10

### Accessories

#### Description



[Cable\\_to\\_Metal\\_Line](#)  
Cable to MSS, CHS and THS