

IEC Appliance Inlet C22, for very hot conditions 155°C, Screw-on or Snap-in Mounting, Front Side



Screw-on from front side
 Flange with countersunk holes
 black



Snap-in mounting from front side
 black



See below:
[Approvals and Compliances](#)

Description

- Panel mount
- Snap-in or screw-on mounting , from front side
- 1 Function :
- Appliance Inlet , Pin temperature 155 °C , Protection class I
- Safety of electrical appliances for household and similar purposes. Meets the requirements for appliances in unattended use. This includes the enhanced requirements of glow wire tests acc. to IEC 60695-2-11 or -12 & -13.
- Solder, Quick Connect or Screw Terminals

References

Alternative: version with line filter [C22F](#)

Weblinks

[pdf data sheet](#), [html datasheet](#), [General Product Information](#), [Distributor-Stock-Check](#), [Accessories](#), [Detailed request for product](#)

Technical Data

Ratings IEC	16A / 250VAC; 50Hz
Ratings UL/CSA	20A / 250VAC; 60Hz
Dielectric Strength	> 6kVAC between L-N > 4kVAC between L/N-PE (1 min/50Hz)
Allowable Operation Temperature	-25 °C to 155 °C
IP-Protection	from front side IP20 acc. to IEC 60529
Protection against electric shock	Suitable for appliances with protection class I acc. to IEC 61140
Terminal	Solder, Quick Connect or Screw Terminals
Panel Thickness S	Snap-in version 1/1.5/2/2.5/3 mm
Material: Housing	PA, black, UL 94V-0

appliance inlet/-outlet	C22 acc. to IEC 60320-1 UL 60320-1, CSA C22.2 no. 60320-1 (for hot conditions) pin-temperature 155 °C, 16A, Protection Class I
-------------------------	--

Approvals and Compliances

Detailed information on product approvals, code requirements, usage instructions and detailed test conditions can be looked up in [Details about Approvals](#)

SCHURTER products are designed for use in industrial environments. They have approvals from independent testing bodies according to national and international standards. Products with specific characteristics and requirements such as required in the automotive sector according to IATF 16949, medical technology according to ISO 13485 or in the aerospace industry can be offered exclusively with customer-specific, individual agreements by SCHURTER.

Approvals



The approval mark is used by the testing authorities to certify compliance with the safety requirements placed on electronic products.

Approval Reference Type: 1681

Approval Logo	Certificates	Certification Body	Description
	KEMA Approvals	KEMA	Certificate Number: 71-110015
	UL Approvals	UL	UL File Number: E96454
	CCC Approvals	CCC	CCC Certificate Number: 2016180204002720



Product standards

Product standards that are referenced

Organization	Design	Standard	Description
	Designed according to	IEC 60320-1	Appliance couplers for household and similar general purposes
	Designed according to	UL 60320-1	Standard for Attachment Plugs and Receptacles
	Designed according to	CSA C22.2 no. 60320-1	General Use Receptacles, Attachment Plugs, and Similar Wiring Devices





Application standards

Application standards where the product can be used

Organization	Design	Standard	Description
	Designed for applications acc.	IEC/UL 60950	IEC 60950-1 includes the basic requirements for the safety of information technology equipment.
	Designed for applications acc.	IEC 60335-1	Safety of electrical appliances for household and similar purposes. Meets the requirements for appliances in unattended use. This includes the enhanced requirements of glow wire tests acc. to IEC 60695-2-11 or -12 & -13.

Compliances

The product complies with following Guide Lines

Identification	Details	Initiator	Description
	CE declaration of conformity	SCHURTER AG	The CE marking declares that the product complies with the applicable requirements laid down in the harmonisation of Community legislation on its affixing in accordance with EU Regulation 765/2008.
	RoHS	SCHURTER AG	Directive RoHS 2011/65/EU, Amendment (EU) 2015/836
	China RoHS	SCHURTER AG	The law SJ / T 11363-2006 (China RoHS) has been in force since 1 March 2007. It is similar to the EU directive RoHS.
	REACH	SCHURTER AG	On 1 June 2007, Regulation (EC) No 1907/2006 on the Registration, Evaluation, Authorization and Restriction of Chemicals 1 (abbreviated as "REACH") entered into force.
	White paper Glow wire test	SCHURTER AG	Meets the requirements of IEC 60335-1 for appliances in unattended use. This includes the enhanced requirements of glow wire tests acc. to IEC 60695-2-11 or -12 & -13.

Dimensions [mm]

Screw-on mounting

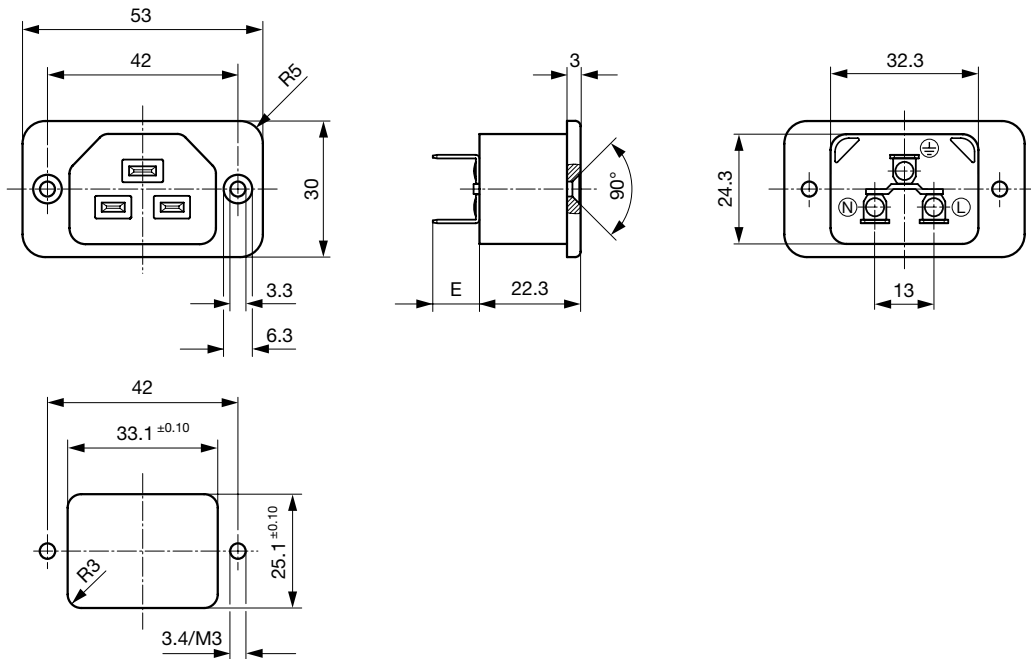

- E: Quick-connect terminals 6.3x0.8 mm: 10.3 mm
- E: Quick-connect terminals 4.8x0.8 mm: 9.3 mm
- E: Solder terminals: 5.1 mm
- E: Screw terminals: 10.3 mm

Snap-in mounting

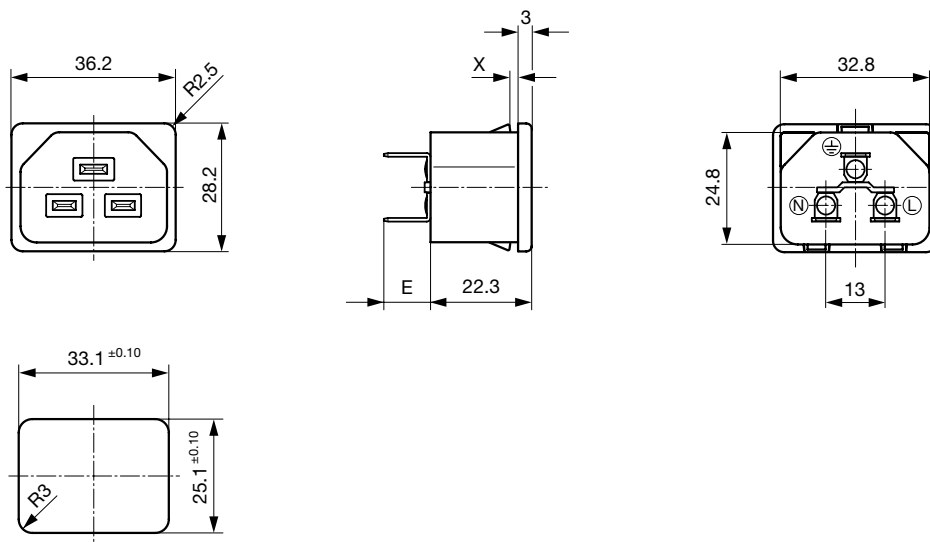

- E: Quick-connect terminals 6.3x0.8 mm: 10.3 mm
- E: Quick-connect terminals 4.8x0.8 mm: 9.3 mm
- E: Solder terminals: 5.1 mm
- E: Screw terminals: 10.3 mm

Config. Code



1681 - H - A B C 0 - D - E G

The characters are placeholders for the correspondingly keys of selections from the key tables.

1681 - H - A B C 0 - D - E G = Type

Type	Configuration key
protection class I	X

1681 - H - A B C 0 - D - E G = Terminals

Terminal L	Configuration key
Blade terminal (4.8 x 0.8 mm) 	8
Blade terminal (6.3 x 0.8 mm) 	9
screw terminal	A
solder terminal (L = 5.1 mm)	D

1681 - H - A B C 0 - D - E G = Terminals

Terminal N	Configuration key
Blade terminal (4.8 x 0.8 mm)	8
Blade terminal (6.3 x 0.8 mm)	9
screw terminal	A
solder terminal (L = 5.1 mm)	D

Symbols similar as in table A

1681 - H - A B C 0 - D - E G = Terminals

Terminal Ground	Configuration key
Blade terminal (4.8 x 0.8 mm)	8
Blade terminal (6.3 x 0.8 mm)	9
screw terminal	A
solder terminal (L = 5.1 mm)	D

Symbols similar as in table A

1681 - H - A B C 0 - D - E G = Color

Color	Configuration key
Black	A

1681 - H - A B C 0 - D - E G = Style

Style	Configuration key
flange with countersunk holes	1
snap-in (s=panel thickness)	4

1681 - H - A B C 0 - D - E G = Dimension S

Dimension "S"	Configuration key
10	
15	
20	
25	
30	

The dimension "S" is displayed in (1/10 mm). This information is also valid for the order code

All Variants

Terminals L / N	Terminal Ground	Style	Panel Thickness s [1/10 mm]	Config. Code	Order Number
solder terminal (L = 5.1 mm)	solder terminal (L = 5.1 mm)	flange with countersunk holes		1681-X-DDD0-A-100-00	6173.0001
Blade terminal (4.8 x 0.8 mm)	Blade terminal (4.8 x 0.8 mm)	flange with countersunk holes		1681-X-8880-A-100-00	6173.0002
Blade terminal (6.3 x 0.8 mm)	Blade terminal (6.3 x 0.8 mm)	flange with countersunk holes		1681-X-9990-A-100-00	6173.0003
screw terminal	screw terminal	flange with countersunk holes		1681-X-AAA0-A-100-00	6173.0004
solder terminal (L = 5.1 mm)	solder terminal (L = 5.1 mm)	snap-in (s=panel thickness)	10	1681-X-DDD0-A-410-00	6173.0009
solder terminal (L = 5.1 mm)	solder terminal (L = 5.1 mm)	snap-in (s=panel thickness)	15	1681-X-DDD0-A-415-00	6173.0010
solder terminal (L = 5.1 mm)	solder terminal (L = 5.1 mm)	snap-in (s=panel thickness)	20	1681-X-DDD0-A-420-00	6173.0011
solder terminal (L = 5.1 mm)	solder terminal (L = 5.1 mm)	snap-in (s=panel thickness)	25	1681-X-DDD0-A-420-00	6173.0012
solder terminal (L = 5.1 mm)	solder terminal (L = 5.1 mm)	snap-in (s=panel thickness)	30	1681-X-DDD0-A-430-00	6173.0013

Terminals L / N	Terminal Ground	Style	Panel Thickness s [1/10 mm]	Config. Code	Order Number
Blade terminal (4.8 x 0.8 mm)	Blade terminal (4.8 x 0.8 mm)	snap-in (s=panel thickness)	10	1681-X-8880-A-410-00	6173.0014
Blade terminal (4.8 x 0.8 mm)	Blade terminal (4.8 x 0.8 mm)	snap-in (s=panel thickness)	15	1681-X-8880-A-415-00	6173.0015
Blade terminal (4.8 x 0.8 mm)	Blade terminal (4.8 x 0.8 mm)	snap-in (s=panel thickness)	20	1681-X-8880-A-420-00	6173.0016
Blade terminal (4.8 x 0.8 mm)	Blade terminal (4.8 x 0.8 mm)	snap-in (s=panel thickness)	25	1681-X-8880-A-425-00	6173.0017
Blade terminal (4.8 x 0.8 mm)	Blade terminal (4.8 x 0.8 mm)	snap-in (s=panel thickness)	30	1681-X-8880-A-430-00	6173.0018
Blade terminal (6.3 x 0.8 mm)	Blade terminal (6.3 x 0.8 mm)	snap-in (s=panel thickness)	10	1681-X-9990-A-410-00	6173.0019
Blade terminal (6.3 x 0.8 mm)	Blade terminal (6.3 x 0.8 mm)	snap-in (s=panel thickness)	15	1681-X-9990-A-415-00	6173.0020
Blade terminal (6.3 x 0.8 mm)	Blade terminal (6.3 x 0.8 mm)	snap-in (s=panel thickness)	20	1681-X-9990-A-420-00	6173.0021
Blade terminal (6.3 x 0.8 mm)	Blade terminal (6.3 x 0.8 mm)	snap-in (s=panel thickness)	25	1681-X-9990-A-425-00	6173.0022
Blade terminal (6.3 x 0.8 mm)	Blade terminal (6.3 x 0.8 mm)	snap-in (s=panel thickness)	30	1681-X-9990-A-430-00	6173.0023

The listed variants should be available from stock. Other versions on request www.schurter.com/contact

Most Popular.

Availability for all products can be searched real-time: <https://www.schurter.com/en/Stock-Check/Stock-Check-SCHURTER>

Packaging unit 50 Pcs

Mating Outlets/Connectors

Category / Description



[Connector Overview complete](#)

1658, Mounting: Power Cord, Screw clamps Connector: IEC C21

1658

1659, Mounting: Power Cord, Cable Connector: IEC C21

1659

[Connector further types to 1681](#)



[Interconnection Cord Overview complete](#)

Cord Sets 16 A, IEC Connector, 2.0 m, Connector IEC C21, H05VV-F3G1.5 / SJT 3x14 AWG, black

6051.5003

[Interconnection Cord further types to 1681](#)



[Power Supply Cord Overview complete](#)

Cord Sets 16 A, Europlug, 2.5 m, Connector IEC C21, H05VV-F3G1.5, black

6051.5001

Cord Sets 16 A, North America, 2.5 m, Connector IEC C21, SJT 3x14 AWG, black

6051.5002

[Power Supply Cord further types to 1681](#)