

IEC Appliance Inlet C14 with Filter, Fuseholder 1- or 2-pole, Line Switch 2-pole, for PCB Mounting



See below:
[Approvals and Compliances](#)

Description

- Panel mount :
Screw-on mounting on PCB , rear-side
- 4 Functions :
Appliance Inlet Protection class I , Line Switch 2-pole , Fuseholder for fuse-links 5 x 20 mm 1- or 2-pole , Line filter in standard and medical version
- V-Lock notch standard
- PCB terminals

Unique Selling Proposition

- Most compact power entry module
- Attractive flat design
- Switch for highest inrush current
- V-Lock cord retaining

Characteristics

- Ultra-compact design. Ideal for low profile designs
- All single elements are already wired
- For added safety "Extra-Safe" fuse drawers are available
- Ideal for application with high transient loads
- For applications according IEC/UL 62368-1 we recommend variants with bleed resistor
Suitable for use in medical equipment according to IEC/UL 60601-1 (1 MOOP, 1 MOPP)

Other versions on request

- Fuse drawer 1-pole, plus spare fuse case
- Fuse drawer 2-pole, with shorting bar
- Other rocker marking
- Line switch, illuminated
- Line switch 1-pole
- Medical Version (M80)
- Protection class II, 70°C

References

- Alternative: version without line filter [DD21](#)
- Alternative: Standard version

Weblinks

[pdf data sheet](#), [html datasheet](#), [General Product Information](#), [Approvals](#), [Distributor-Stock-Check](#), [Accessories](#), [Detailed request for product](#)

Technical Data

| | | | |
|---------------------------------|--|-----------------------------------|--|
| Ratings IEC | 1 - 10A @ Ta 40 °C / 250VAC; 50Hz | Appliance inlet/-outlet | C14 acc. to IEC 60320-1 |
| Ratings UL/CSA | 1 - 10A @ Ta 40 °C / 250VAC; 50/60Hz | Fuseholder | UL 498 CSA C22.2 no. 42 (for cold conditions) pin-temperature 70 °C, 10A, Protection Class I |
| Leakage Current | standard < 0.5 mA (250 V / 60Hz) medical < 5 µA (250 V / 60 Hz) | Rated Power Acceptance @ Ta 23 °C | 1-/2-pole, Shocksafe category PC2 acc. to IEC 60127-6, for fuse-links 5 x 20mm |
| Dielectric Strength | > 1.7 kVDC between L-N > 2.7 kVDC between L/N-PE Test voltage (1 min/50Hz) | Power Acceptance @ Ta > 23°C | 5 x 20: 2W (1 pole)/ 1.6W (2-pole) per pole |
| Allowable Operation Temperature | -25 °C to 85 °C | Line Switch | Admissible power acceptance at higher ambient temperature see derating curves |
| Climatic Category | 25/085/21 acc. to IEC 60068-1 | Line Filter | Rocker switch 2-pole, non-illuminated, acc. to IEC 61058-1 Technical Details |
| IP-Protection | front side IP40 acc. to IEC 60529 | MTBF | Standard and Medical Version, IEC 60939, UL 1283, CSA C22.2 no. 8 Technical Details |
| Protection Class | Suitable for appliances with protection class I acc. to IEC 61140 | | > 2'000'000 h acc. to MIL-HB-217 F |
| Terminal | For PCB mounting 3 mm additional quick connect 6.3 x 0.8 mm | | |
| Panel Thickness S | Screw-on mounting: max 3mm Mounting screw torque max 0.5Nm | | |
| Material | Thermoplastic, black, UL 94V-0 | | |

Approvals and Compliances



Detailed information on product approvals, code requirements, usage instructions and detailed test conditions can be looked up in [Details about Approvals](#)

SCHURTER products are designed for use in industrial environments. They have approvals from independent testing bodies according to national and international standards. Products with specific characteristics and requirements such as required in the automotive sector according to IATF 16949, medical technology according to ISO 13485 or in the aerospace industry can be offered exclusively with customer-specific, individual agreements by SCHURTER.

Approvals









The approval mark is used by the testing authorities to certify compliance with the safety requirements placed on electronic products.

Approval Reference Type: DD22

| Approval Logo | Certificates | Certification Body | Description |
|--|-------------------------------|--------------------|------------------------------|
|  | VDE Approvals | VDE | Certificate Number: 40001522 |
|  | UL Approvals | UL | UR File Number: E72928 |



Product standards

Product standards that are referenced

| Organization | Design | Standard | Description |
|--|-----------------------|------------------|---|
|  | Designed according to | IEC 60320-1 | Appliance couplers for household and similar general purposes |
|  | Designed according to | IEC 60939 | Passive filters for suppressing electromagnetic interference |
|  | Designed according to | IEC 60127-6 | Miniature fuses. Part 6. Fuse-holders for miniature fuse-links |
|  | Designed according to | IEC 61058-1 | Switches for appliances. Part 1. General requirements |
|  | Designed according to | UL 498 | Standard for Attachment Plugs and Receptacles |
|  | Designed according to | UL 1283 | Electromagnetic interference filters |
|  | Designed according to | CSA C22.2 no. 42 | General Use Receptacles, Attachment Plugs, and Similar Wiring Devices |
|  | Designed according to | CSA C22.2 no. 8 | Electromagnetic interference (EMI) filters |









Application standards

Application standards where the product can be used

| Organization | Design | Standard | Description |
|--|--------------------------------|----------------|--|
|  | Designed for applications acc. | IEC/UL 62368-1 | Audio/video, information and communication technology equipment - Part 1: Safety requirements |
|  | Designed for applications acc. | IEC 60601-1 | Medical electrical equipment - Part 1: General requirements for basic safety and essential performance |
|  | Designed for applications acc. | IEC 60335-1 | Safety of electrical appliances for household and similar purposes. Meets the requirements for appliances in unattended use. This includes the enhanced requirements of glow wire tests acc. to IEC 60695-2-11 or -12 & -13. |

Compliances

The product complies with following Guide Lines

| Identification | Details | Initiator | Description |
|---|--|-------------|--|
|  | CE declaration of conformity | SCHURTER AG | The CE marking declares that the product complies with the applicable requirements laid down in the harmonisation of Community legislation on its affixing in accordance with EU Regulation 765/2008. |
|  | UKCA declaration of conformity | SCHURTER AG | The UKCA marking declares that the product complies with the applicable requirements laid down in the British Amendment of Regulation (EC) 765/2008. |
|  | RoHS | SCHURTER AG | Directive RoHS 2011/65/EU, Amendment (EU) 2015/863 |
|  | China RoHS | SCHURTER AG | The law SJ / T 11363-2006 (China RoHS) has been in force since 1 March 2007. It is similar to the EU directive RoHS. |
|  | REACH | SCHURTER AG | On 1 June 2007, Regulation (EC) No 1907/2006 on the Registration, Evaluation, Authorization and Restriction of Chemicals 1 (abbreviated as "REACH") entered into force. |
|  | | SCHURTER AG | V-Lock system are based on a matching plug-dose combination. The connector is equipped with a notch intended for use with the latching cordset. The cord latching system prevents against accidental removal of the cordset. |
|  | White Paper Glow wire test | SCHURTER AG | Meets the requirements of IEC 60335-1 for appliances in unattended use. This includes the enhanced requirements of glow wire tests acc. to IEC 60695-2-11 or -12 &-13. |
|  | Medical Equipment | SCHURTER AG | Suitable for use in medical equipment according to IEC/UL 60601-1 (1 MOOP, 1 MOPP) |

Dimension [mm]

Screw-on version

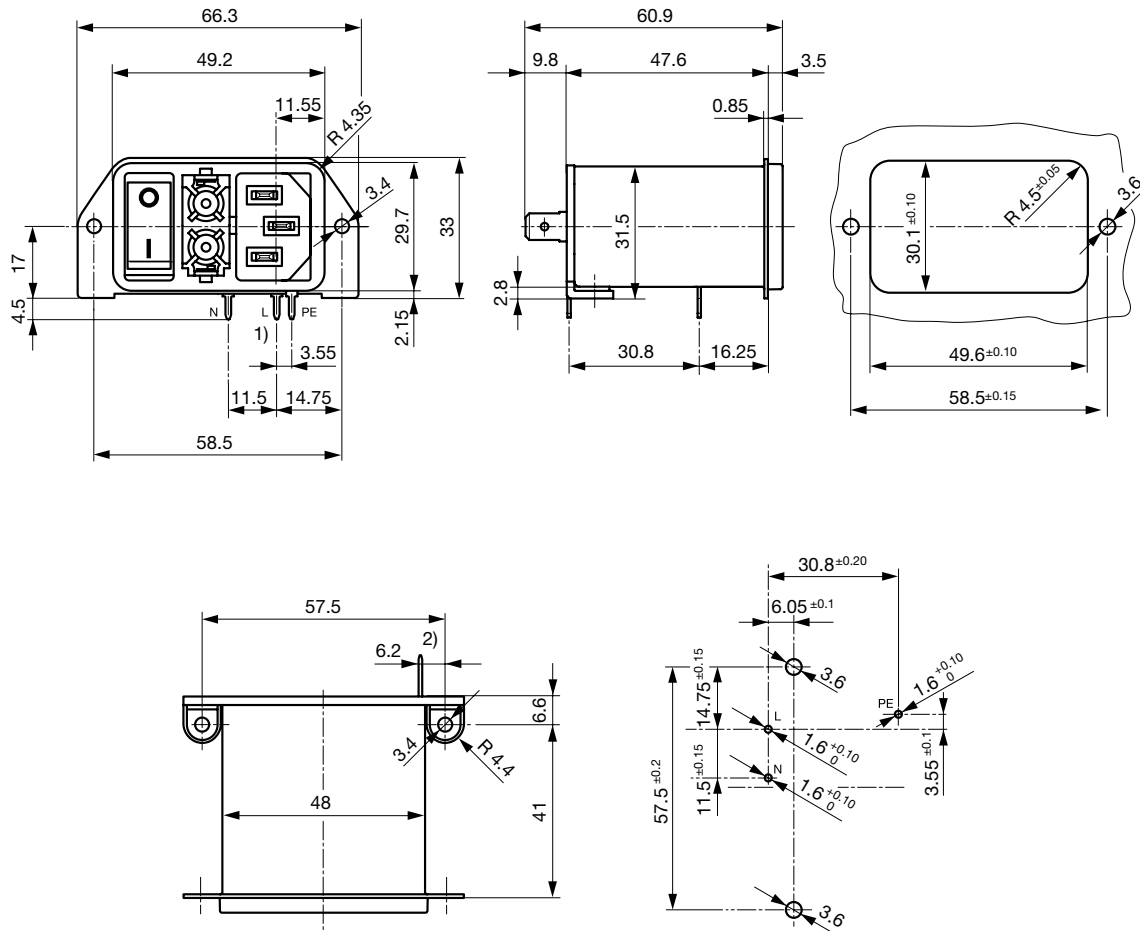

- 1) all terminals with 1.25 x 0.8
- 2) Quick connect terminal 6.3 x 0.8

Technical Data of Filter-Components

| Rated Current [A] | Filter-Type | Inductances L [mH] | Capacitance CX [nF] | Capacitance CY [nF] | R [MΩ] |
|-------------------|----------------------|--------------------|---------------------|---------------------|--------|
| 1 | Standard version | 2 x 10 | 100 | 2.2 | 1 |
| 2 | Standard version | 2 x 4 | 100 | 2.2 | 1 |
| 4 | Standard version | 2 x 1.5 | 100 | 2.2 | 1 |
| 6 | Standard version | 2 x 0.8 | 100 | 2.2 | 1 |
| 10 | Standard version | 2 x 0.3 | 100 | 2.2 | 1 |
| 1 | Medical Version (M5) | 2 x 10 | 100 | - | 1 |
| 2 | Medical Version (M5) | 2 x 4 | 100 | - | 1 |
| 4 | Medical Version (M5) | 2 x 1.5 | 100 | - | 1 |
| 6 | Medical Version (M5) | 2 x 0.8 | 100 | - | 1 |
| 10 | Medical Version (M5) | 2 x 0.3 | 100 | - | 1 |

Diagrams

Filter Standard
Non-illuminated

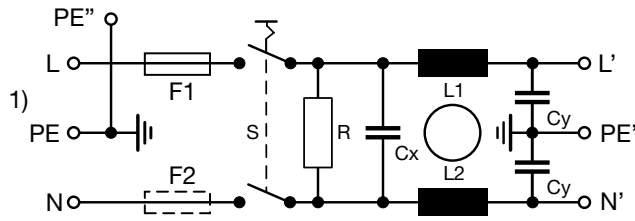

1) Line
2) Load

Medical Version (M5)
Non-illuminated

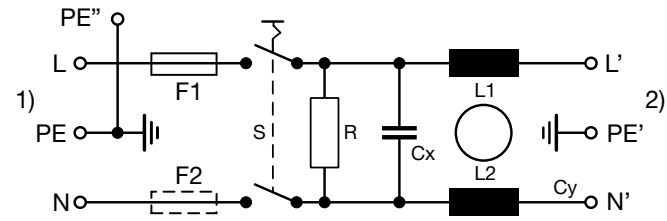

1) Line
2) Load

Derating Curves

1-pole

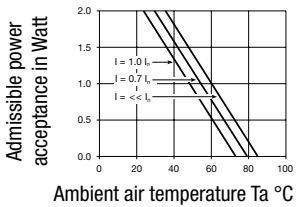

2-pole

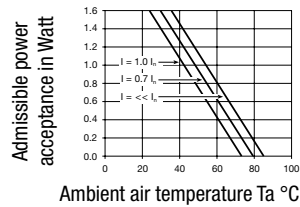

Attenuation Loss

--- 50Ω differential mode ____ 50Ω common mode

Standard version

1 A

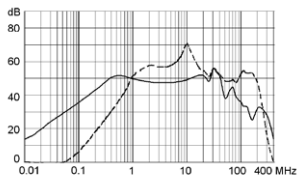

2 A

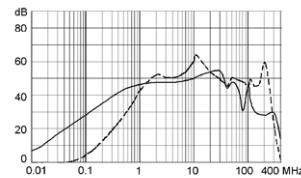

4 A

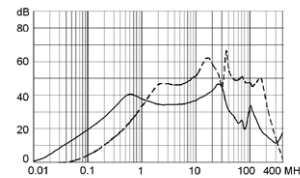

6 A

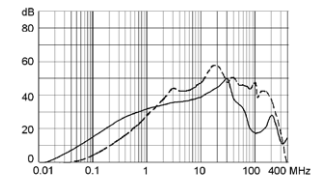

10 A

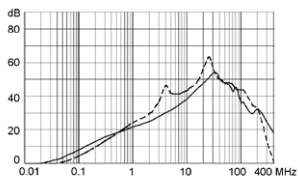

Medical version (M5)

1 A

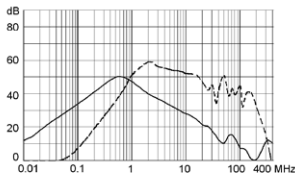

2 A

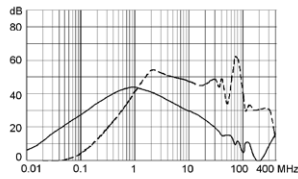

4 A

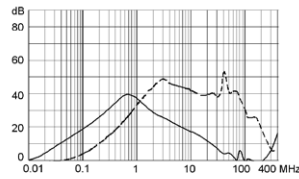

6 A

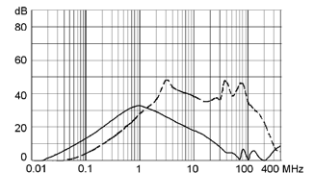

10 A

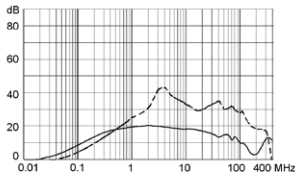

All Variants

| Rated Current [A] | Filter-Type | Fuseholder | Line Switch | Illumination | Order Number |
|-------------------|----------------------|------------|-------------|-----------------|----------------|
| 1 | Standard version | 1-pole | 2-pole | non-illuminated | DD22.1111.1111 |
| 2 | Standard version | 1-pole | 2-pole | non-illuminated | DD22.2111.1111 |
| 4 | Standard version | 1-pole | 2-pole | non-illuminated | DD22.4111.1111 |
| 6 | Standard version | 1-pole | 2-pole | non-illuminated | DD22.6111.1111 |
| 10 | Standard version | 1-pole | 2-pole | non-illuminated | DD22.9111.1111 |
| 1 | Standard version | 2-pole | 2-pole | non-illuminated | DD22.1121.1111 |
| 2 | Standard version | 2-pole | 2-pole | non-illuminated | DD22.2121.1111 |
| 4 | Standard version | 2-pole | 2-pole | non-illuminated | DD22.4121.1111 |
| 6 | Standard version | 2-pole | 2-pole | non-illuminated | DD22.6121.1111 |
| 10 | Standard version | 2-pole | 2-pole | non-illuminated | DD22.9121.1111 |
| 1 | Medical Version (M5) | 2-pole | 2-pole | non-illuminated | DD22.1321.1111 |
| 2 | Medical Version (M5) | 2-pole | 2-pole | non-illuminated | DD22.2321.1111 |
| 4 | Medical Version (M5) | 2-pole | 2-pole | non-illuminated | DD22.4321.1111 |
| 6 | Medical Version (M5) | 2-pole | 2-pole | non-illuminated | DD22.6321.1111 |
| 10 | Medical Version (M5) | 2-pole | 2-pole | non-illuminated | DD22.9321.1111 |

Most Popular.

Availability for all products can be searched real-time: <https://www.schurter.com/en/Stock-Check/Stock-Check-SCHURTER>

The fuse drawer is not included and must be ordered separately (see required accessory).

Packaging unit

20 Pcs

Required Accessory

Description

Fusedrawer 2

Fusedrawer for Fuse Links 5x20 mm, with or without Voltage Selector Insert



| | |
|--------------------|-----------|
| Fingergrip, 2-pole | 4301.1401 |
| Extra-Safe, 2-pole | 4301.1403 |
| Fingergrip, 1-pole | 4301.1405 |
| Extra-Safe, 1-pole | 4301.1407 |

...

Mating Outlets/Connectors

Category / Description

Appliance Outlet Overview complete



| | |
|--|------|
| 4787, Mounting: Screw-on mounting, Appliance Outlet: IEC Solder terminals, 10 A, Suitable for appliances with protection class I | 4787 |
| 4788, Mounting: Snap-in version, Appliance Outlet: IEC Solder / Quick Connect, 10 A, Suitable for appliances with protection class I | 4788 |
| IEC Appliance Outlet F or H, Screw-on Mounting, Front Side, Solder, PCB or Quick-connect Terminal | 5091 |

Connector Overview complete



| | |
|---|---------|
| 4782 Mounting: Power Cord, 3 x 1 mm ² / 3 x 18 AWG, Cable, Connector: IEC C13 | 4782 |
| 4785 Mounting: Power Cord, 3 x 1 mm ² / 3 x 18 AWG, Cable, Connector: IEC C13 | 4785 |
| 4300-06 Mounting: Power Cord, 3 x 1 mm ² / 3 x 18 AWG, Cable, Connector: IEC C13 | 4300-06 |
| 4781 Mounting: Power Cord, Cable, Connector: IEC C15 | 4781 |
| 4784 Mounting: Power Cord, 3 x 1 mm ² / 3 x 18 AWG, Cable, Connector: IEC C15 | 4784 |

...

Mating Outlets/Connectors shuttered

Connector Overview complete



| | |
|--|------|
| 4783 Mounting: Power Cord, 3 x 1 mm ² / 3 x 18 AWG, Cable, Connector: IEC C13 | 4783 |
|--|------|

Power Cord Overview complete



| | |
|---|---------|
| VAC13KS, Overview, V-Lock cord retaining, diverse Connector IEC C13, diverse, black | VAC13KS |
|---|---------|