

IEC Appliance Inlet C14 with Filter, Front or Rear side Mounting



Snap-In Version with quick connect terminals
6.3 x 0.8 mm



Screw-on Version
with quick connect terminals 6.3 x 0.8 mm



Screw-On Version with flexible wires



See below:
[Approvals and Compliances](#)

Description

- Panel mount :
Snap-in or screw-on mounting from front or rear-side
- 2 Functions :
Appliance Inlet , Line-filter in standard version
- Quick connect terminals or wires

Characteristics

- Compact design with optimal shielding
- All single elements are already wired
- For standard applications
- Suitable for use in equipment according to IEC/UL 60950

References

We recommend for new applications the type [5120](#)
 Last order date: 31.12.2014

Weblinks

[pdf data sheet](#), [html datasheet](#), [General Product Information](#), [Distributor-Stock-Check](#), [Accessories](#), [Detailed request for product](#), [Landing Page](#)

Newly available variants corresponding to V-Lock mating cordset. The connector is equipped with a notch intended for use with the latching cordset. The cord latching system prevents against accidental removal of the cordset.

Technical Data

Ratings IEC	1 - 10A @ Ta 40 °C / 250 VAC; 50Hz	appliance inlet/-outlet	C14 acc. to IEC 60320-1, UL 498, CSA C22.2 no. 42 (for cold conditions) pin-temperature 70 °C, 10A, Protection Class I
Ratings UL/CSA	1 - 10A @ Ta 40 °C / 250 VAC; 60Hz	Line Filter	Standard Version, IEC 60939, UL 1283, CSA C22.2 no. 8 Technical Details
Dielectric Strength	> 1.7 kVDC between L-N > 2.7 kVDC between L/N-PE Test voltage (2 sec)	MTBF	> 3'100'000 h acc. to MIL-HB-217 F
Impulse Withstand Voltage	> 2.5 kV between L-N > 5 kV between L/N-PE		
Allowable Operation Temperature	-25 °C to 85 °C		
Climatic Category	25/085/21 acc. to IEC 60068-1		
IP-Protection	from front side IP40 acc. to IEC 60529		
Protection Class	Suitable for appliances with protection class I acc. to IEC 61140		
Terminal	Quick connect terminals or wires Quick connect terminals 6.3 x 0.8 mm straight		
Panel Thickness S	Screw max 8 mm Mounting screw torque max 0.5 Nm Snap-in 1 mm to 3 mm Aluminium 1.5-3 mm, steel 1-3 mm, not suitable for plastic material		
Material: Housing	Thermoplastic, black, UL 94V-0		

Approvals and Compliances



Detailed information on product approvals, code requirements, usage instructions and detailed test conditions can be looked up in [Details about Approvals](#)

SCHURTER products are designed for use in industrial environments. They have approvals from independent testing bodies according to national and international standards. Products with specific characteristics and requirements such as required in the automotive sector according to IATF 16949, medical technology according to ISO 13485 or in the aerospace industry can be offered exclusively with customer-specific, individual agreements by SCHURTER.

Approvals







The approval mark is used by the testing authorities to certify compliance with the safety requirements placed on electronic products.

Approval Reference Type: FGS

Approval Logo	Certificates	Certification Body	Description
	VDE Approvals	VDE	Certificate Number: 40004665
	UL Approvals	UL	UL File Number: E72928

Product standards

Product standards that are referenced

Organization	Design	Standard	Description
	Designed according to	IEC 60320-1	Appliance couplers for household and similar general purposes
	Designed according to	IEC 60939	Passive filters for suppressing electromagnetic interference
	Designed according to	IEC 61058-1	Switches for appliances. Part 1. General requirements
	Designed according to	UL 498	Standard for Attachment Plugs and Receptacles
	Designed according to	UL 1283	Electromagnetic interference filters
	Designed according to	CSA C22.2 no. 42	General Use Receptacles, Attachment Plugs, and Similar Wiring Devices
	Designed according to	CSA C22.2 no. 8	Electromagnetic interference (EMI) filters





Application standards

Application standards where the product can be used

Organization	Design	Standard	Description
	Designed for applications acc.	IEC/UL 60950	IEC 60950-1 includes the basic requirements for the safety of information technology equipment.

Compliances

The product complies with following Guide Lines

Identification	Details	Initiator	Description
	CE declaration of conformity	SCHURTER AG	The CE marking declares that the product complies with the applicable requirements laid down in the harmonisation of Community legislation on its affixing in accordance with EU Regulation 765/2008.
	RoHS	SCHURTER AG	Directive RoHS 2011/65/EU, Amendment (EU) 2015/863
	China RoHS	SCHURTER AG	The law SJ / T 11363-2006 (China RoHS) has been in force since 1 March 2007. It is similar to the EU directive RoHS.
	REACH	SCHURTER AG	On 1 June 2007, Regulation (EC) No 1907/2006 on the Registration, Evaluation, Authorization and Restriction of Chemicals 1 (abbreviated as "REACH") entered into force.
	Landing Page V-Lock	SCHURTER AG	V-Lock system are based on a matching plug-dose combination. The connector is equipped with a notch intended for use with the latching cordset. The cord latching system prevents against accidental removal of the cordset.

Dimension [mm]

Snap-in, front side, quick connect terminals

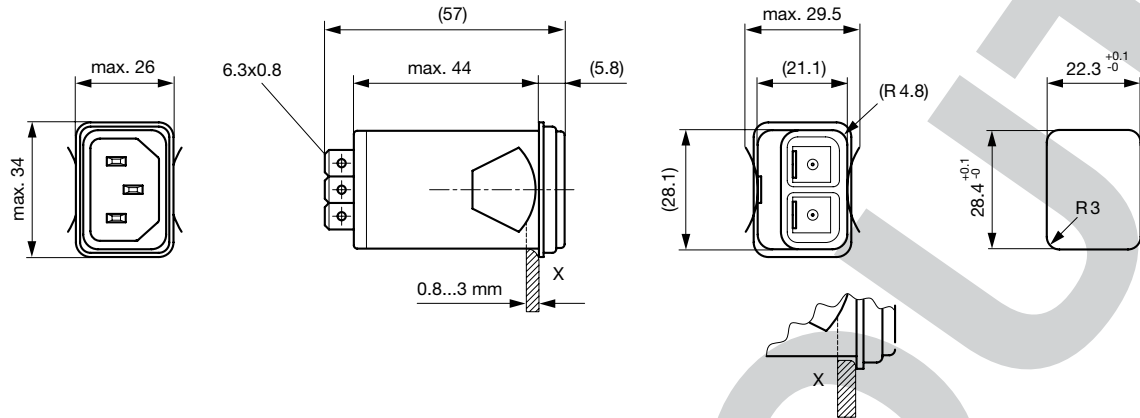

Screw-on, rear side, quick connect terminal

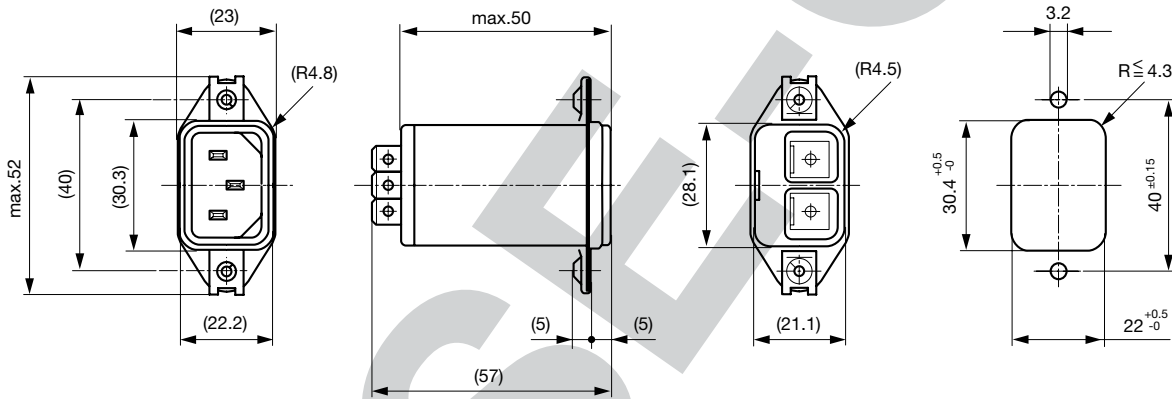

Screw-on, rear side, flexible wires

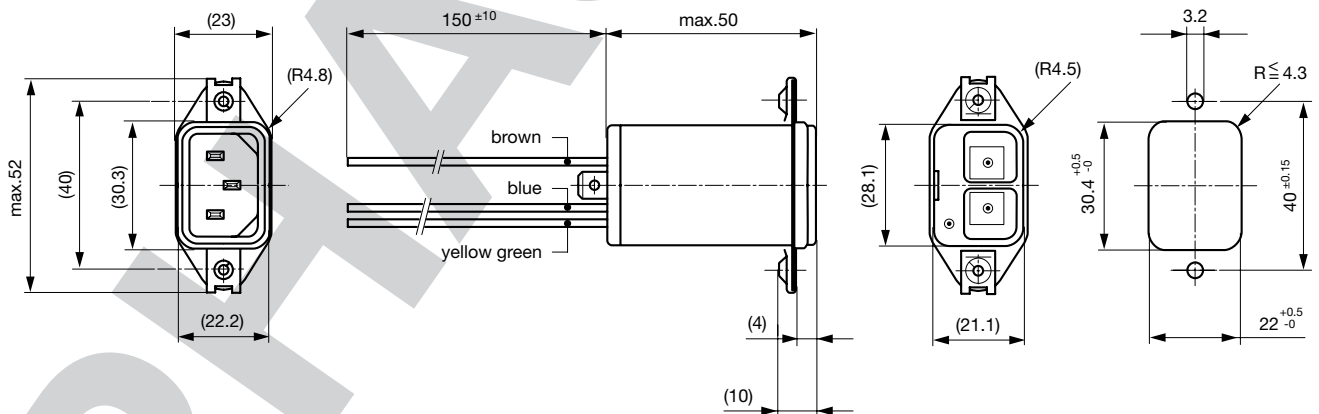

Technical Data of Filter-Components

Rated Current [A]	Filter-Type	Inductances L [mH]	Capacitance CX [nF]
1	Standard	2 x 10	47
2	Standard	2 x 4	47
4	Standard	2 x 1.5	47
6	Standard	2 x 0.8	47
10	Standard	2 x 0.3	47

Diagrams

Standard Version

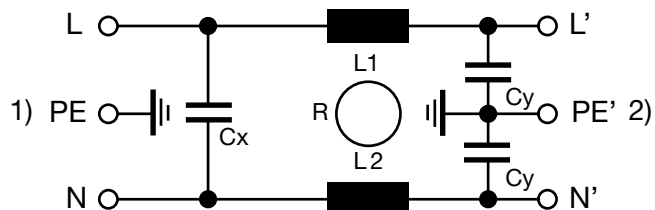

- 1) Line
- 2) Load

Attenuation Loss

Standard version

----- 50Ω differential mode ____ 50Ω common mode

1 A

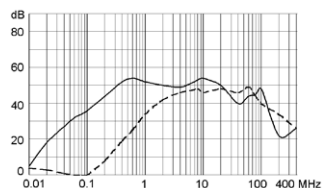

2 A

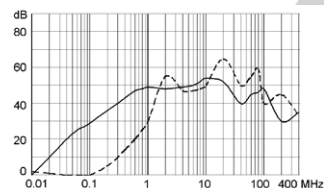

4 A

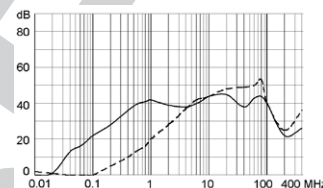

6 A

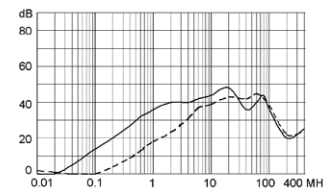

10 A

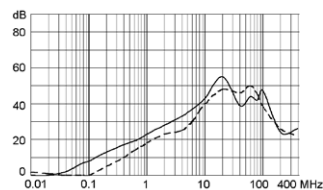

All Variants

Rated Current [A]	Mounting	Panel mounting	Terminal	Order Number
1	Snap-in	Mounting from front side	Quick connect terminals 6.3 x 0.8 mm	4300.5011
2	Snap-in	Mounting from front side	Quick connect terminals 6.3 x 0.8 mm	4300.5012
4	Snap-in	Mounting from front side	Quick connect terminals 6.3 x 0.8 mm	4300.5013
6	Snap-in	Mounting from front side	Quick connect terminals 6.3 x 0.8 mm	4300.5014
10	Snap-in	Mounting from front side	Quick connect terminals 6.3 x 0.8 mm	4300.5015
1	Screw	Screw-on from rear side	Quick connect terminals 6.3 x 0.8 mm	4300.5091
2	Screw	Screw-on from rear side	Quick connect terminals 6.3 x 0.8 mm	4300.5092
4	Screw	Screw-on from rear side	Quick connect terminals 6.3 x 0.8 mm	4300.5093
6	Screw	Screw-on from rear side	Quick connect terminals 6.3 x 0.8 mm	4300.5094
10	Screw	Screw-on from rear side	Quick connect terminals 6.3 x 0.8 mm	4300.5095
1	Screw	Screw-on from rear side	Flexible wire AWG18	4300.5071

Rated Current [A]	Mounting	Panel mounting	Terminal	Order Number
2	Screw	Screw-on from rear side	Flexible wire AWG18	4300.5072
4	Screw	Screw-on from rear side	Flexible wire AWG18	4300.5073
6	Screw	Screw-on from rear side	Flexible wire AWG18	4300.5074
10	Screw	Screw-on from rear side	Flexible wire AWG18	4300.5075

Availability for all products can be searched real-time: <https://www.schurter.com/en/Stock-Check/Stock-Check-SCHURTER>

Packaging unit 10 Pcs

Accessories

Description

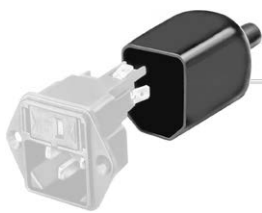

Assorted Covers
Rear Cover

0859.0048

Mating Outlets/Connectors

Category / Description

Appliance Outlet Overview complete



4787, Mounting: Screw-on mounting, Appliance Outlet: IEC Solder terminals, 10 A, Suitable for appliances with protection class I 4787

4788, Mounting: Snap-in version, Appliance Outlet: IEC Solder terminals or quick connect terminals, 10 A, Suitable for appliances with protection class I 4788

IEC Appliance Outlet F or H, Screw-on Mounting, Front Side, Solder, PCB or Quick-connect Terminal 5091

[Appliance Outlet further types to FGS](#)

Connector Overview complete



4022 Mounting: Power Supply Cord, 3 x 1.5 mm², Screw clamps, Connector: IEC C13 4022

4782 Mounting: Power Cord, 3 x 1 mm² / 3 x 18 AWG, Cable, Connector: IEC C13 4782

4012 Mounting: Power Supply Cord, 3 x 1 mm², Screw clamps, Connector: IEC C13 4012

4785 Mounting: Power Cord, 3 x 1 mm² / 3 x 18 AWG, Cable, Connector: IEC C13 4785

4300-06 Mounting: Power Cord, 3 x 1 mm² / 3 x 18 AWG, Cable, Connector: IEC C13 4300-06

[Connector further types to FGS](#) ...

Mating Outlets/Connectors shuttered

Power Cord Overview complete



VAC13KS, Overview, V-Lock cord retaining, diverse Connector IEC C13, diverse, black VAC13KS

[Power Cord further types to FGS](#)