

IEC Appliance Inlet C14 with Filter, Fuseholder 1- or 2-pole (5x20 mm or 6.3x32 mm), optional Voltage Selector (step switch)



KFC
with voltage selector
3-digits



KFC
without voltage selector



See below:
[Approvals and Compliances](#)

Description

- Panel mount :
Screw-on mounting front side
- 4 Functions :
Appliance Inlet Protection class I , Fuseholder with interchangeable fuse drawer for Fuse-links 5x20 mm or 6.3x32 mm , with or without voltage selector (step switch) , Line filter in standard and medical version
- Quick connect terminals 4.8 x 0.8 mm

Unique Selling Proposition

- Multifunctional power entry module
- Suitable for various fuses
- Highly resistant since fully potted
- V-Lock cord retaining

Characteristics

- All single elements are already wired
- The fuse drawer "Fingergrip" can be removed by hand
- For applications according IEC/UL 62368-1 we recommend variants with bleed resistor
- Suitable for use in medical equipment according to IEC/UL 60601-1 (1 MOOP, 1 MOPP)

Other versions on request

- Variant with notch for V-Lock mating Cordsets

References

Alternative: version without line filter [KEC](#)
 Alternative: Standard version

Weblinks

[pdf data sheet](#), [html datasheet](#), [General Product Information](#), [Approvals](#), [Distributor-Stock-Check](#), [Accessories](#), [Detailed request for product](#)

Newly available variants corresponding to V-Lock mating cordset. The connector is equipped with a notch intended for use with the latching cordset. The cord latching system prevents against accidental removal of the cordset.

Technical Data

| | | | |
|---------------------------------|-----------------------------------------------------------------------------|-----------------------------------|------------------------------------------------------------------------------------------------------------------------|
| Ratings IEC | 1 - 10A @ Ta 40 °C / 250 VAC; 50Hz | Appliance inlet/-outlet | C14 acc. to IEC 60320-1, UL 498, CSA C22.2 no. 42 (for cold conditions) pin-temperature 70 °C, 10A, Protection Class I |
| Ratings UL/CSA | 1 - 10A @ Ta 40 °C / 250 VAC; 60Hz | Fuseholder | 1-/2-pole, Shocksafe category PC2 acc. to IEC 60127-6, for fuse-links 5 x 20 / 6.3 x 32 mm |
| Leakage Current | standard < 0.5 mA (250 V / 60Hz) medical < 5 µA (250 V / 60 Hz) | Rated Power Acceptance @ Ta 23 °C | 5 x 20: 2.5W (1 pole)/ 2W (2-pole) per pole 6.3 x 32: 3.15W (1 pole)/ 2.5W (2-pole) per pole |
| Dielectric Strength | > 1.7 kVDC between L-N > 2.7 kVDC between L/N-PE Test voltage (2 sec) | Power Acceptance @ Ta > 23°C | Admissible power acceptance at higher ambient temperature see derating curves |
| Allowable Operation Temperature | -25 °C to 85 °C | Voltage Selector | optional, step, 3 pos. |
| Climatic Category | 25/085/21 acc. to IEC 60068-1 | Line Filter | Standard and Medical Version, IEC 60939, UL 1283, CSA C22.2 no. 8 Technical Details |
| IP-Protection | front side IP40 acc. to IEC 60529 | MTBF | > 1'700'000h acc. to MIL-HB-217 F |
| Protection Class | Suitable for appliances with protection class I acc. to IEC 61140 | | |
| Terminal | Quick connect terminals 4.8 x 0.8 mm | | |
| Panel Thickness S | Screw: max 8 mm Mounting screw torque max 0.5 Nm | | |
| Material | Thermoplastic, black, UL 94V-0 | | |

Approvals and Compliances



Detailed information on product approvals, code requirements, usage instructions and detailed test conditions can be looked up in [Details about Approvals](#)

SCHURTER products are designed for use in industrial environments. They have approvals from independent testing bodies according to national and international standards. Products with specific characteristics and requirements such as required in the automotive sector according to IATF 16949, medical technology according to ISO 13485 or in the aerospace industry can be offered exclusively with customer-specific, individual agreements by SCHURTER.

Approvals









The approval mark is used by the testing authorities to certify compliance with the safety requirements placed on electronic products.

Approval Reference Type: KFC

| Approval Logo | Certificates | Certification Body | Description |
|----------------------------------------------------------------------------------|---------------|--------------------|---------------------------------------------------|
|  | VDE Approvals | VDE | Certificate Number: 40004665 (FKO, FKP, FKQ, FKR) |
|  | UL Approvals | UL | UR File Number: E72928 (FKO, FKP, FKQ, FKR) |
|  | CQC Approvals | CQC | CQC Certificate Number: CQC19001212148 |



Product standards

Product standards that are referenced

| Organization | Design | Standard | Description |
|-----------------------------------------------------------------------------------|-----------------------|------------------|-----------------------------------------------------------------------|
|  | Designed according to | IEC 60320-1 | Appliance couplers for household and similar general purposes |
|  | Designed according to | IEC 60939 | Passive filters for suppressing electromagnetic interference |
|  | Designed according to | IEC 60127-6 | Miniature fuses. Part 6. Fuse-holders for miniature fuse-links |
|  | Designed according to | IEC 61058-1 | Switches for appliances. Part 1. General requirements |
|  | Designed according to | UL 498 | Standard for Attachment Plugs and Receptacles |
|  | Designed according to | UL 1283 | Passive filters for suppressing electromagnetic interference |
|  | Designed according to | CSA C22.2 no. 42 | General Use Receptacles, Attachment Plugs, and Similar Wiring Devices |
|  | Designed according to | CSA C22.2 no. 8 | Electromagnetic interference (EMI) filters |









Application standards

Application standards where the product can be used

| Organization | Design | Standard | Description |
|------------------------------------------------------------------------------------|--------------------------------|----------------|------------------------------------------------------------------------------------------------------------------------------------------------------------------------------------------------------------------------------|
|  | Suitable for applications acc. | IEC/UL 62368-1 | Audio/video, information and communication technology equipment - Part 1: Safety requirements |
|  | Suitable for applications acc. | IEC 60601-1 | Medical electrical equipment - Part 1: General requirements for basic safety and essential performance |
|  | Suitable for applications acc. | IEC 60335-1 | Safety of electrical appliances for household and similar purposes. Meets the requirements for appliances in unattended use. This includes the enhanced requirements of glow wire tests acc. to IEC 60695-2-11 or -12 & -13. |

Compliances

The product complies with following Guide Lines

| Identification | Details | Initiator | Description |
|------------------------------------------------------------------------------------|--------------------------------|-------------|------------------------------------------------------------------------------------------------------------------------------------------------------------------------------------------------------------------------------|
|  | CE declaration of conformity | SCHURTER AG | The CE marking declares that the product complies with the applicable requirements laid down in the harmonisation of Community legislation on its affixing in accordance with EU Regulation 765/2008. |
|  | UKCA declaration of conformity | SCHURTER AG | The UKCA marking declares that the product complies with the applicable requirements laid down in the British Amendment of Regulation (EC) 765/2008. |
|  | RoHS | SCHURTER AG | Directive RoHS 2011/65/EU, Amendment (EU) 2015/863 |
|  | China RoHS | SCHURTER AG | The law SJ / T 11363-2006 (China RoHS) has been in force since 1 March 2007. It is similar to the EU directive RoHS. |
|  | REACH | SCHURTER AG | On 1 June 2007, Regulation (EC) No 1907/2006 on the Registration, Evaluation, Authorization and Restriction of Chemicals 1 (abbreviated as "REACH") entered into force. |
|  | | SCHURTER AG | V-Lock system are based on a matching plug-dose combination. The connector is equipped with a notch intended for use with the latching cordset. The cord latching system prevents against accidental removal of the cordset. |
|  | White Paper Glow wire test | SCHURTER AG | Meets the requirements of IEC 60335-1 for appliances in unattended use. This includes the enhanced requirements of glow wire tests acc. to IEC 60695-2-11 or -12 & -13. |
|  | Medical Equipment | SCHURTER AG | Suitable for use in medical equipment according to IEC/UL 60601-1 (1 MOOP, 1 MOPP) |

Dimension [mm]
KFC

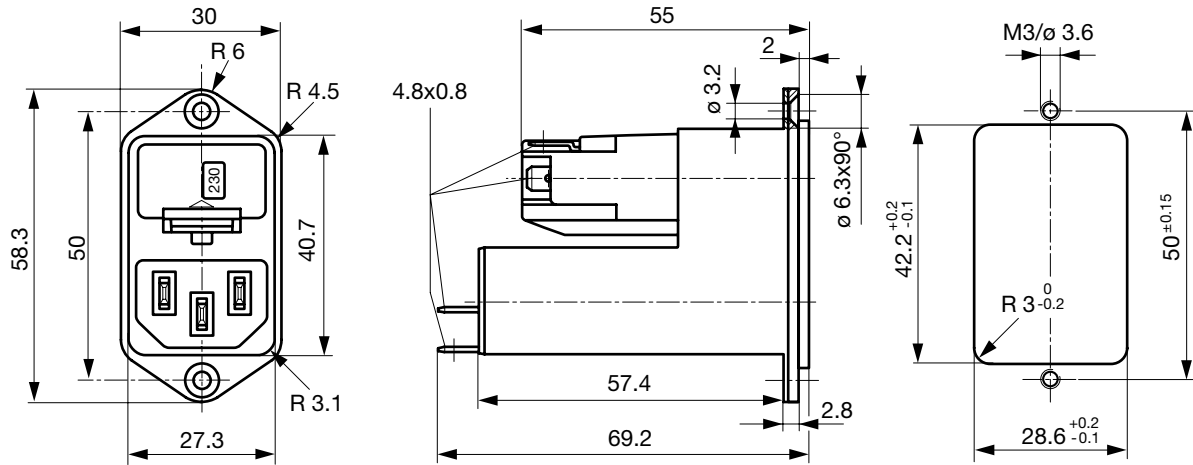

Technical Data of Filter-Components

| Rated Current [A] | Filter-Type | Inductances L [mH] | Capacitance CX [nF] | Capacitance CY [nF] | R [MΩ] |
|-------------------|----------------------|--------------------|---------------------|---------------------|--------|
| 1 | Standard version | 2 x 10 | 68 | 2.2 | - |
| 2 | Standard version | 2 x 4 | 68 | 2.2 | - |
| 4 | Standard version | 2 x 1.5 | 68 | 2.2 | - |
| 6 | Standard version | 2 x 0.8 | 68 | 2.2 | - |
| 10 | Standard version | 2 x 0.3 | 68 | 2.2 | - |
| 1 | Medical Version (M5) | 2 x 10 | 68 | - | 1 |
| 2 | Medical Version (M5) | 2 x 4 | 68 | - | 1 |
| 4 | Medical Version (M5) | 2 x 1.5 | 68 | - | 1 |
| 6 | Medical Version (M5) | 2 x 0.8 | 68 | - | 1 |
| 10 | Medical Version (M5) | 2 x 0.3 | 68 | - | 1 |

Diagrams

Standard version
with voltage selector

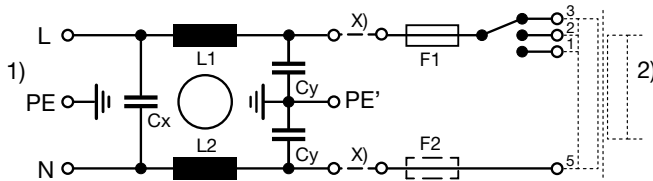

x) external connection to be made by the customer

- 1) Line
- 2) Load

Medical Version (M5)
with voltage selector

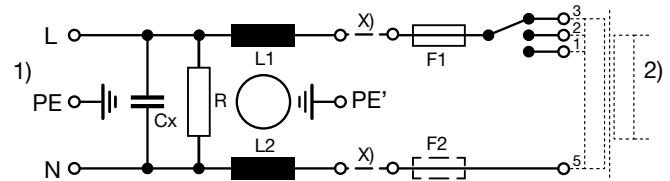

x) external connection to be made by the customer

- 1) Line
- 2) Load

Derating Curves

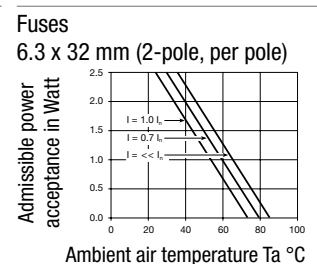
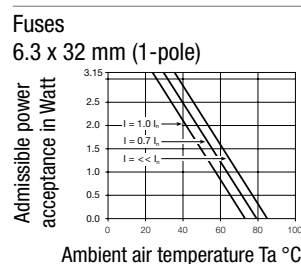
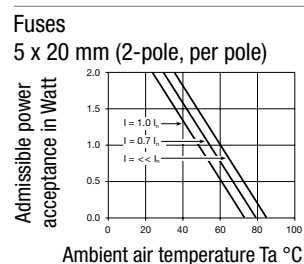
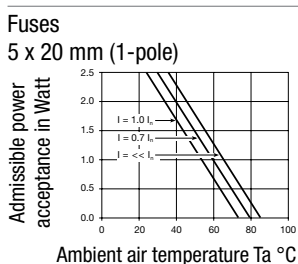

Attenuation Loss

--- 50Ω differential mode ____ 50Ω common mode

Standard version

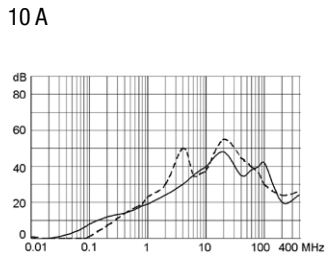
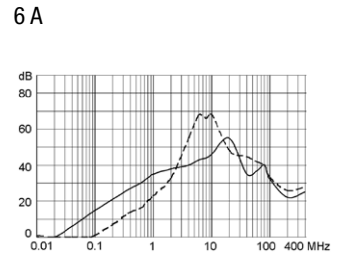
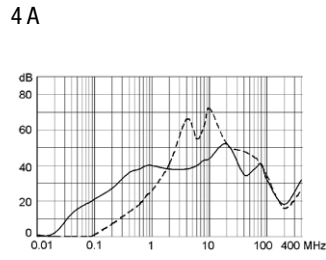
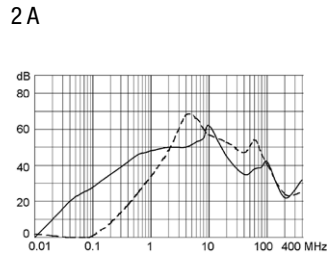
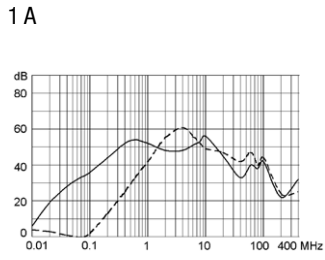

Medical version (M5)

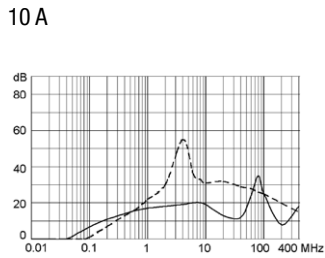
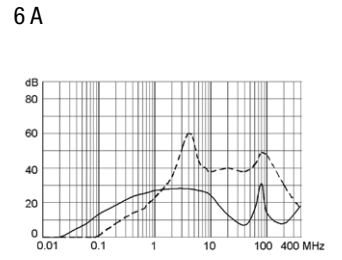
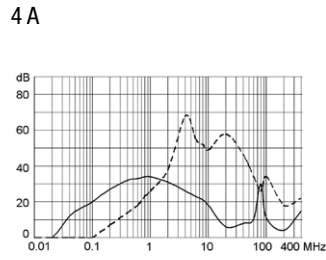
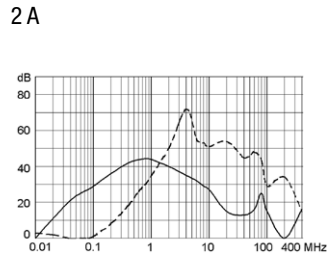
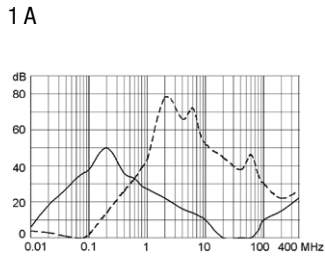

Variants

| Rated Current [A] | Filter-Type | Fuseholder | Voltage Selector | V-Lock | Order Number |
|-------------------|------------------|------------|------------------|--------|--------------|
| 1 | Standard version | 1-pole | - | | 4303.5011 |
| 2 | Standard version | 1-pole | - | | 4303.5012 |
| 4 | Standard version | 1-pole | - | | 4303.5013 |
| 6 | Standard version | 1-pole | - | | 4303.5014 |
| 10 | Standard version | 1-pole | - | | 4303.5015 |
| 1 | Standard version | 1-pole | 3 pos. | | 4303.5031 |
| 2 | Standard version | 1-pole | 3 pos. | | 4303.5032 |
| 4 | Standard version | 1-pole | 3 pos. | | 4303.5033 |
| 6 | Standard version | 1-pole | 3 pos. | | 4303.5034 |
| 10 | Standard version | 1-pole | 3 pos. | | 4303.5035 |
| 1 | Standard version | 2-pole | - | | 4303.5001 |
| 2 | Standard version | 2-pole | - | | 4303.5002 |
| 4 | Standard version | 2-pole | - | | 4303.5003 |
| 6 | Standard version | 2-pole | - | | 4303.5004 |

| Rated Current [A] | Filter-Type | Fuseholder | Voltage Selector | V-Lock | Order Number |
|-------------------|----------------------|------------|------------------|--------|--------------|
| 10 | Standard version | 2-pole | - | | 4303.5005 |
| 1 | Standard version | 2-pole | 3 pos. | | 4303.5021 |
| 2 | Standard version | 2-pole | 3 pos. | | 4303.5022 |
| 4 | Standard version | 2-pole | 3 pos. | | 4303.5023 |
| 6 | Standard version | 2-pole | 3 pos. | | 4303.5024 |
| 10 | Standard version | 2-pole | 3 pos. | | 4303.5025 |
| 1 | Medical Version (M5) | 2-pole | 3 pos. | | 4303.5221 |
| 2 | Medical Version (M5) | 2-pole | 3 pos. | | 4303.5223 |
| 4 | Medical Version (M5) | 2-pole | 3 pos. | | 4303.5225 |
| 6 | Medical Version (M5) | 2-pole | 3 pos. | | 4303.5227 |
| 10 | Medical Version (M5) | 2-pole | 3 pos. | ● | 4303.5209.21 |
| 10 | Medical Version (M5) | 2-pole | 3 pos. | | 4303.5229 |

Availability for all products can be searched real-time: <https://www.schurter.com/en/info-center/support-tools/stock-check-distributors>

The fuse drawer is not included and must be ordered separately (see required accessory).

Packaging unit 10 Pcs

Required Accessory

Description

Fusedrawer_3

Fusedrawer for Fuse Links 5x20 mm resp. 6.3x32 mm



| | |
|------------------------------------------------------------------|--------------|
| Fingergrip, 5 x 20, 2-pole, Voltage Selector | 4303.2014.00 |
| Fingergrip, 5 x 20, 2-pole, Voltage Selector, 100, 120, 220, 240 | 4303.2014.01 |
| Fingergrip, 5 x 20, 2-pole, Voltage Selector, 110, 150, 220 | 4303.2014.02 |
| Fingergrip, 5 x 20, 2-pole, Voltage Selector, 110, 220 | 4303.2014.03 |

...

Accessories



RC320

Rear Cover for Power Entry Module



Cord_retaining_kits

Cord retaining strain relief

| | |
|--------------|-----------|
| Flat head, A | 4700.0001 |
|--------------|-----------|

Mating Outlets/Connectors

Category / Description



[Appliance Outlet Overview complete](#)

| | |
|----------------------------------------------------------------------------------------------------------------------------------|------|
| 4787, Mounting: Screw-on mounting, Appliance Outlet: IEC Solder terminals, 10 A, Suitable for appliances with protection class I | 4787 |
| IEC Appliance Outlet F or H, Screw-on Mounting, Front Side, Solder, PCB or Quick-connect Terminal | 5091 |

[Connector Overview complete](#)



| | |
|---------------------------------------------------------------------------------------------|---------|
| 4782 Mounting: Power Cord, 3 x 1 mm ² / 3 x 18 AWG, Cable, Connector: IEC C13 | 4782 |
| 4785 Mounting: Power Cord, 3 x 1 mm ² / 3 x 18 AWG, Cable, Connector: IEC C13 | 4785 |
| 4300-06 Mounting: Power Cord, 3 x 1 mm ² / 3 x 18 AWG, Cable, Connector: IEC C13 | 4300-06 |
| 4781 Mounting: Power Cord, Cable, Connector: IEC C15 | 4781 |
| 4784 Mounting: Power Cord, 3 x 1 mm ² / 3 x 18 AWG, Cable, Connector: IEC C15 | 4784 |

Mating Outlets/Connectors shuttered



[Connector Overview complete](#)

| | |
|------------------------------------------------------------------------------------------|------|
| 4783 Mounting: Power Cord, 3 x 1 mm ² / 3 x 18 AWG, Cable, Connector: IEC C13 | 4783 |
|------------------------------------------------------------------------------------------|------|



[Power Cord Overview complete](#)

| | |
|-------------------------------------------------------------------------------------|---------|
| VAC13KS, Overview, V-Lock cord retaining, diverse Connector IEC C13, diverse, black | VAC13KS |
|-------------------------------------------------------------------------------------|---------|