

Membrane Switch Frontpanel Short Stroke 18 mm



Membrane Switch Frontpanel Short Stroke 18 mm
 square
 White, lettered



Membrane Switch Frontpanel Short Stroke 18 mm
 round
 red, lettered



Membrane Switch Frontpanel Short Stroke 18 mm
 round
 green

See below:

Approvals and Compliances

Description

- Momentary action switch available in version square or round in different colours
- High lifetime with 5 million actuations
- Front and rear tested to degree of protection IP65 Snap-in type from front side
- Solder terminals

Unique Selling Proposition

- Unique mechanical switches with tactile feedback
- Small mounting depth
- Various lettering options

Technical Data

Electrical Data

Impulse Withstand Voltage (ESD) ± 16 kV

Contact Material Silver

Switching Voltage min. 5 VDC, max. 48 VDC

Switching current max. 125 mA

Rated Switching Capacity 0.72 W

Lifetime > 1 million actuations at Rated Switching Capacity

Contact Resistance < 50 m Ω
 < 150 m Ω after lifetime

Insulation Resistance > 100 M Ω
 Duration of Bounce typ. 0.1 ms

Contact Material Gold

Switching Voltage min. 50 mVDC, max. 24 VDC

Switching current max. 80 mA

Rated Switching Capacity 0.36 W

Lifetime > 1 million actuations at Rated Switching Capacity

Contact Resistance < 50 m Ω
 < 150 m Ω after lifetime

Insulation Resistance > 100 M Ω
 Duration of Bounce typ. 0.1 ms

Weblinks

[pdf data sheet](#), [html datasheet](#), [General Product Information](#), [CAD-Drawings](#), [Product News](#), [Detailed request for product](#)

Mechanical Data

Actuating Force 3 ± 1 N

Actuating Travel 0.5 ± 0.1 mm

End Stop Strength > 50 N

Lifetime > 1 million actuations

Mounting screw torque 8N/cm

Climatical Data

Operating Temperature -25 °C to 60 °C

Storage Temperature -25 °C to 60 °C

IP-Protection IP65 (only with accessory kit)

Other Data

Contact Material Ag / Au

Soldering Data

Solderability 235 °C / 2 sec (IEC 60068-2-20 Test Ta Method 1)

Resistance to Soldering Heat 260 °C / 5 sec (IEC 60068-2-20 Test Tb Method 1A)

Material

Housing Thermoplastic (PES)

Socket Thermoplastic (PES)

Bezel Thermoplastic (PBT)

Contact CuZn37 3 μ m Ni 2 μ m Au; CuZn37 2.5 μ m Ag

Soldering Aid Tin-plated

Approvals and Compliances

Detailed information on product approvals, code requirements, usage instructions and detailed test conditions can be looked up in [Details about Approvals](#)

SCHURTER products are designed for use in industrial environments. They have approvals from independent testing bodies according to national and international standards. Products with specific characteristics and requirements such as required in the automotive sector according to IATF 16949, medical technology according to ISO 13485 or in the aerospace industry can be offered exclusively with customer-specific, individual agreements by SCHURTER.



Application standards

Application standards where the product can be used

Organization	Design	Standard	Description
	Suitable for applications acc.	IEC/UL 62368-1	Audio/video, information and communication technology equipment - Part 1: Safety requirements

Compliances

The product complies with following Guide Lines

Identification	Details	Initiator	Description
	RoHS	SCHURTER AG	Directive RoHS 2011/65/EU, Amendment (EU) 2015/863
	China RoHS	SCHURTER AG	The law SJ / T 11363-2006 (China RoHS) has been in force since 1 March 2007. It is similar to the EU directive RoHS.
	REACH	SCHURTER AG	On 1 June 2007, Regulation (EC) No 1907/2006 on the Registration, Evaluation, Authorization and Restriction of Chemicals 1 (abbreviated as "REACH") entered into force.

Dimension [mm]

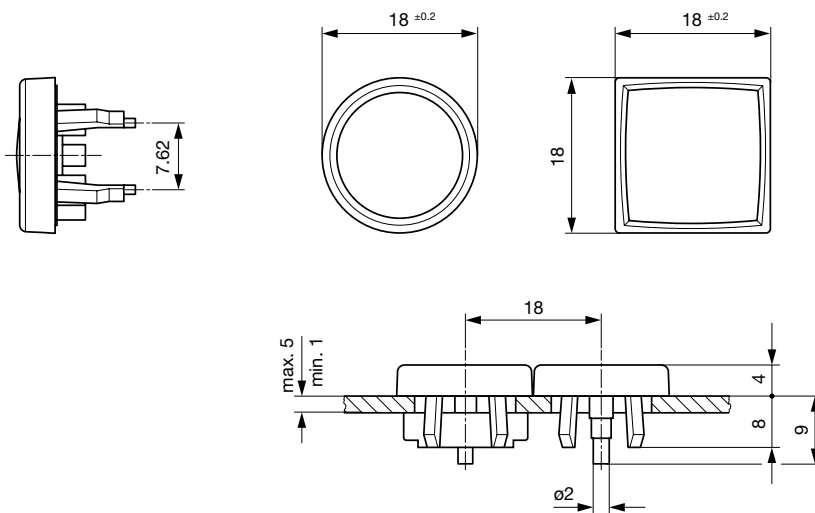

Dimension

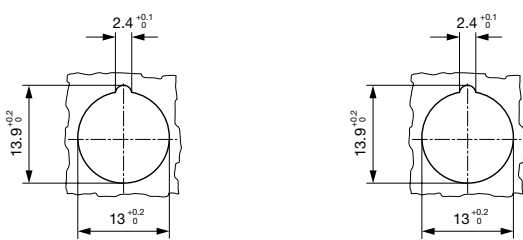

Drilling diagram

Drilling diagram

Assembly Instructions

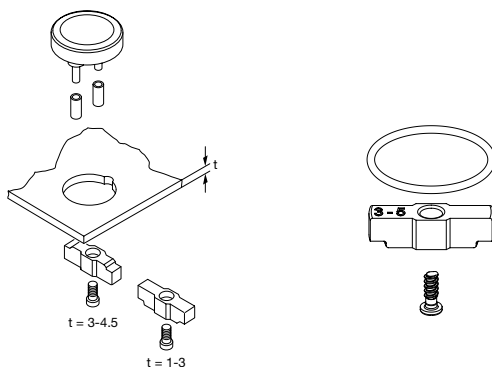

Accessory kit IP65 has to be ordered separately

Diagrams



Order Index Lettering

Laser Marking

001 =A	021 =U	041 =÷	061 =EIN
002 =B	022 =V	042 =*	062 =AUS
003 =C	023 =W	043 ==	063 =AUF
004 =D	024 =X	044 =#	064 =AB
005 =E	025 =Y	045 =↔	065 =ON
006 =F	026 =Z	046 =‡	066 =OFF
007 =G	027 =0	047 =→	067 =UP
008 =H	028 =1	048 =←	068 =DOWN
009 =I	029 =2	049 =↓	069 =HIGH
010 =J	030 =3	050 =↑	070 =LOW
011 =K	031 =4	051 =%	071 =ON/OFF
012 =L	032 =5	052 =√	072 =START
013 =M	033 =6	053 =CTRL	073 =RESET
014 =N	034 =7	054 =RETURN	074 =⏻
015 =O	035 =8	055 =SHIFT	075 =⚙️
016 =P	036 =9	056 =LOCK	076 =🔒
017 =Q	037 =+	057 =STOP	077 =Ⓜ️
018 =R	038 =-	058 =ENTER	
019 =S	039 =.	059 =BACK	
020 =T	040 =x	060 =LINE	











Please note that the font size depends on the number of characters

Letter heights and Fonts

- Single characters, Univers 65
- Legends max. 6 characters in line, Univers 65
- Insert label and front foil anthracite, RAO 7016
- Characters and symbols light grey, RAL 7035

Order number key

M	C	S	18	-	A	-	BK	-	GN	-	038	-	AG	-	S	-	P	-	00	-	S
			1		2		3		4		5		6		7		8		9		10

Diameter				1
18 mm	=			18
Housing shape				2
Round	=			A
Square	=			B
Bezel color				3
Black	=			BK
White	=			WT
Grey	=			GY
Yellow	=			YL
Green	=			GN
Red	=			RD
Orange	=			OR
Actuator color				4
Black	=			BK
White	=			WT
Grey	=			GY
Yellow	=			YL
Green	=			GN
Red	=			RD
Orange	=			OR
Marking type				5
Customer spec.	=			CCC
None	=			000
Standard symbols	=			001-077
See in the table "Order Index Lettering"				
Contact material				6
Silver	=			AG
Gold	=			AU
Mounting				7
Print	=			P
Snap-in (1.0-5.0 mm)	=			S
Terminal switch				8
Pin	=			P
Solder	=			S
Accessories				9
None	=			00
IP65 kit	=			IP
Execution Type				10
Standard	=			S
Customized	=			C

All Variants

Kontakte	Form	Color Bezel	Color Touchpad	Marking	Bestellnummer
Ag	round	white	white	without Lettering	1241.1104.8098
Ag	square	black	red	without Lettering	1241.1100.7093
Ag	square	black	green	without Lettering	1241.1100.7095
Ag	square	black	black	without Lettering	1241.1100.7097
Ag	round	black	yellow	without Lettering	1241.1104.7091
Ag	round	black	red	without Lettering	1241.1104.7093
Ag	round	black	green	without Lettering	1241.1104.7095
Ag	round	black	grey	without Lettering	1241.1104.7096
Ag	round	black	black	without Lettering	1241.1104.7097
Ag	round with soldering aid	black	black	without Lettering	1241.1113.7097
Accessory kit IP65	-	-	-	-	0098.9201

For Lettering versions see tables "Lettering" and "Order Index Lettering" to determine the symbol

Availability for all products can be searched real-time: <https://www.schurter.com/en/info-center/support-tools/stock-check-distributors>

Packaging unit 100 pcs