

Membrane Switch Printmount Short Stroke 18mm



Membrane Switch
 red
 lettered



Membrane Switch
 black
 lettered

See below:

[Approvals and Compliances](#)

Description

- Momentary action switch available in version square or round in different colours
- High-quality gold and silver contacts
- Ideal switch for applications with multiple key points
- Solder terminals

Unique Selling Proposition

- Unique mechanical switches with tactile feedback
- Extremely low design
- Various lettering options
- Long life time

Weblinks

[pdf data sheet](#), [html datasheet](#), [General Product Information](#), [CAD-Drawings](#), [Product News](#), [Detailed request for product](#)

Technical Data

Electrical Data

Contact Material Silver

Switching Voltage	min. 5 VDC , max. 48 VDC
Switching current	max. 125 mA
Rated Switching Capacity	0.72 W
Lifetime	> 1 million at Rated Switching Capacity
Contact Resistance	< 50 mΩ < 150 mΩ after lifetime
Insulation Resistance	> 100 MΩ
Duration of Bounce	typ. 0.1 ms

Contact Material Gold

Switching Voltage	min. 50 mVDC, max. 24 VDC
Switching current	max. 80 mA
Rated Switching Capacity	0.36 W
Lifetime	> 1 million at Rated Switching Capacity
Contact Resistance	< 50 mΩ < 150 mΩ after lifetime
Insulation Resistance	> 100 MΩ
Duration of Bounce	typ. 0.1 ms

Mechanical Data

Actuating Force	3 ± 1 N
Actuating Travel	0.5 ± 0.1 mm
End Stop Strength	> 50 N
Lifetime	> 1 million actuations

Climatical Data

Operating Temperature	-25 °C to 60 °C
Storage Temperature	-25 °C to 60 °C
IP-Protection	IP65

Other Data

Contact Material	Ag / Au
------------------	---------

Soldering Data

Solderability	235 °C / 2 sec (IEC 60068-2-20 Test Ta Method 1)
Resistance to Soldering Heat	260 °C / 5 sec (IEC 60068-2-20 Test Tb Method 1A)

Material

Housing	Thermoplastic (PES)
Socket	Thermoplastic (PES)
Bezel	Thermoplastic (PBT)
Contact	CuZn37 3 μm Ni 2 μm Au; CuZn37 2.5 μm Ag

Approvals and Compliances

Detailed information on product approvals, code requirements, usage instructions and detailed test conditions can be looked up in [Details about Approvals](#)

SCHURTER products are designed for use in industrial environments. They have approvals from independent testing bodies according to national and international standards. Products with specific characteristics and requirements such as required in the automotive sector according to IATF 16949, medical technology according to ISO 13485 or in the aerospace industry can be offered exclusively with customer-specific, individual agreements by SCHURTER.



Application standards

Application standards where the product can be used

Organization	Design	Standard	Description
	Suitable for applications acc.	IEC/UL 62368-1	Audio/video, information and communication technology equipment - Part 1: Safety requirements

Compliances

The product complies with following Guide Lines

Identification	Details	Initiator	Description
	RoHS	SCHURTER AG	Directive RoHS 2011/65/EU, Amendment (EU) 2015/863
	China RoHS	SCHURTER AG	The law SJ / T 11363-2006 (China RoHS) has been in force since 1 March 2007. It is similar to the EU directive RoHS.
	REACH	SCHURTER AG	On 1 June 2007, Regulation (EC) No 1907/2006 on the Registration, Evaluation, Authorization and Restriction of Chemicals 1 (abbreviated as "REACH") entered into force.

Dimension [mm]

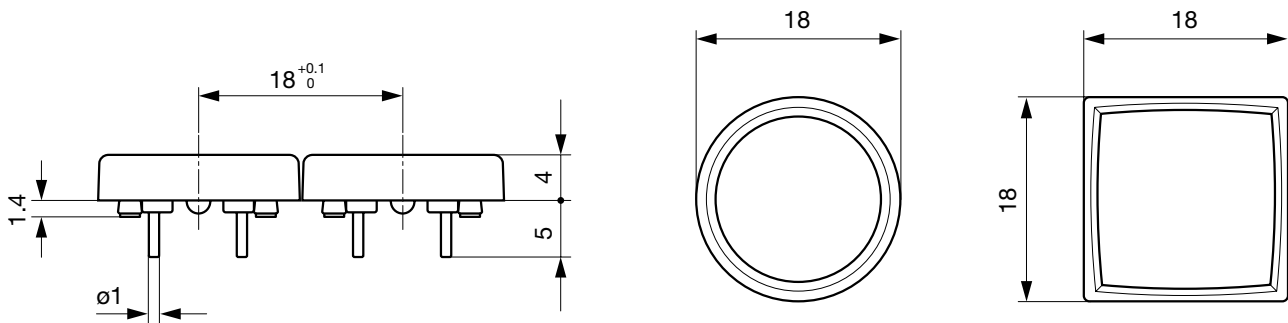

Dimension

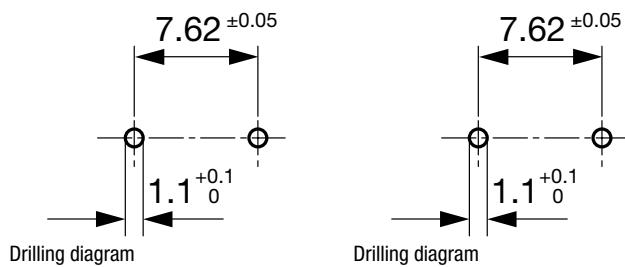

Diagrams

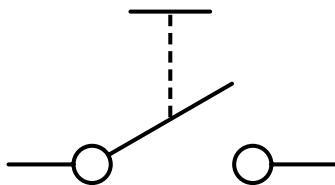

Order Index Lettering

Laser Marking			
001 =A	021 =U	041 =÷	061 =EIN
002 =B	022 =V	042 =*	062 =AUS
003 =C	023 =W	043 ==	063 =AUF
004 =D	024 =X	044 =#	064 =AB
005 =E	025 =Y	045 =↔	065 =ON
006 =F	026 =Z	046 =‡	066 =OFF
007 =G	027 =0	047 =→	067 =UP
008 =H	028 =1	048 =←	068 =DOWN
009 =I	029 =2	049 =↓	069 =HIGH
010 =J	030 =3	050 =↑	070 =LOW
011 =K	031 =4	051 =%	071 =ON/OFF
012 =L	032 =5	052 =√	072 =START
013 =M	033 =6	053 =CTRL	073 =RESET
014 =N	034 =7	054 =RETURN	074 =⏻
015 =O	035 =8	055 =SHIFT	075 =☀
016 =P	036 =9	056 =LOCK	076 =🔒
017 =Q	037 =+	057 =STOP	077 =Ⓜ
018 =R	038 =-	058 =ENTER	
019 =S	039 =.	059 =BACK	
020 =T	040 =x	060 =LINE	

Please note that the font size depends on the number of characters

Letter heights and Fonts

- Single characters, Univers 65
- Legends max. 6 characters in line, Univers 65
- Insert label and front foil anthracite, RAO 7016
- Characters and symbols light grey, RAL 7035

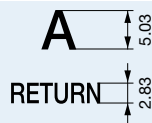

All Variants

Kontakte	Form	Color Bezel	Color Touchpad	Marking	Bestellnummer
Ag	round	black	yellow	without Lettering	1241.1110.7091
Ag	round	black	red	without Lettering	1241.1110.7093
Ag	round	black	black	without Lettering	1241.1110.7097
Au	round	black	red	without Lettering	1241.1111.7093

For Lettering versions see tables "Lettering" and "Order Index Lettering" to determine the symbol

Most Popular.

Availability for all products can be searched real-time: <https://www.schurter.com/en/Stock-Check/Stock-Check-SCHURTER>

Packaging unit

100 pcs