

1-stage filter for 3-phase systems

new



Case 4C-50

See below:

**Approvals and Compliances**

**Description**

- Terminals for three phases and ground
- 1 stage
- Very high attenuation
- Industrial or low leakage current versions

**Unique Selling Proposition**

- Compact design with small footprint
- Single-stage filter for high efficiency
- Light weight design
- Wide temperature range

**Applications**

- Voltage rating 520 VAC for world wide acceptance
- Protection against interference voltage from the mains
- Especially designed for industrial applications such as: Frequency Converters, Stepper Motor Drives, UPS-Systems, Inverters
- Variants Machine Safety suitable for machine applications according to IEC 60204-1
- Suitable for use in equipment according to IEC/UL 62368-1

**Weblinks**

[pdf data sheet](#), [html datasheet](#), [General Product Information](#), [Approvals](#), [Distributor-Stock-Check](#), [Detailed request for product](#), [Microsite](#)

**Technical Data**

Rated Current	16 - 230A
Rated voltage	300/520VAC, 50/60 Hz
Approval for	16 - 230A @ 50 °C / 300/520VAC; 50/60Hz
Overload Current	1.5 x I <sub>r</sub> for 1 minute, per hour
Dielectric Strength	> 2.25kVDC between L-L > 2.75kVDC between L-PE Test voltage 2 sec
Number of Filter Stages	1-stage
Weight	0.9 - 4kg
Material: Housing	Metal
Sealing Compound	UL 94V-0

Mounting	Screw-on mounting on chassis
Terminal	Screw clamps
Operating Temperature	-40 °C to 100 °C
Climatic Category	40/100/21 acc. to IEC 60068-1
Degree of Protection	IP20 acc. to IEC 60529
Protection Class	Suitable for appliances with protection class I acc. to IEC 61140
MTBF	> 200'000h acc. to MIL-HB-217 F

**Approvals and Compliances**

Detailed information on product approvals, code requirements, usage instructions and detailed test conditions can be looked up in [Details about Approvals](#)

SCHURTER products are designed for use in industrial environments. They have approvals from independent testing bodies according to national and international standards. Products with specific characteristics and requirements such as required in the automotive sector according to IATF 16949, medical technology according to ISO 13485 or in the aerospace industry can be offered exclusively with customer-specific, individual agreements by SCHURTER.

**Approvals**



The approval mark is used by the testing authorities to certify compliance with the safety requirements placed on electronic products.

Approval Reference Type: FMAC NEO

Approval Logo	Certificates	Certification Body	Description
	<a href="#">VDE Approvals</a>	VDE	Certificate Number: 40049000
	<a href="#">UL Approvals</a>	UL	UR File Number: E72928

### Product standards

Product standards that are referenced

Organization	Design	Standard	Description
	Designed according to	IEC 60939	Passive filters for suppressing electromagnetic interference
	Designed according to	UL 1283	Passive filters for suppressing electromagnetic interference





### Application standards

Application standards where the product can be used

Organization	Design	Standard	Description
	Suitable for applications acc.	IEC/UL 62368-1	Audio/video, information and communication technology equipment - Part 1: Safety requirements

### Compliances

The product complies with following Guide Lines

Identification	Details	Initiator	Description
	<a href="#">CE declaration of conformity</a>	SCHURTER AG	The CE marking declares that the product complies with the applicable requirements laid down in the harmonisation of Community legislation on its affixing in accordance with EU Regulation 765/2008.
	<a href="#">UKCA declaration of conformity</a>	SCHURTER AG	The UKCA marking declares that the product complies with the applicable requirements laid down in the British Amendment of Regulation (EC) 765/2008.
	RoHS	SCHURTER AG	Directive RoHS 2011/65/EU, Amendment (EU) 2015/863
	China RoHS	SCHURTER AG	The law SJ / T 11363-2006 (China RoHS) has been in force since 1 March 2007. It is similar to the EU directive RoHS.
	REACH	SCHURTER AG	On 1 June 2007, Regulation (EC) No 1907/2006 on the Registration, Evaluation, Authorization and Restriction of Chemicals 1 (abbreviated as "REACH") entered into force.

### Dimension [mm]

Case 5A-4

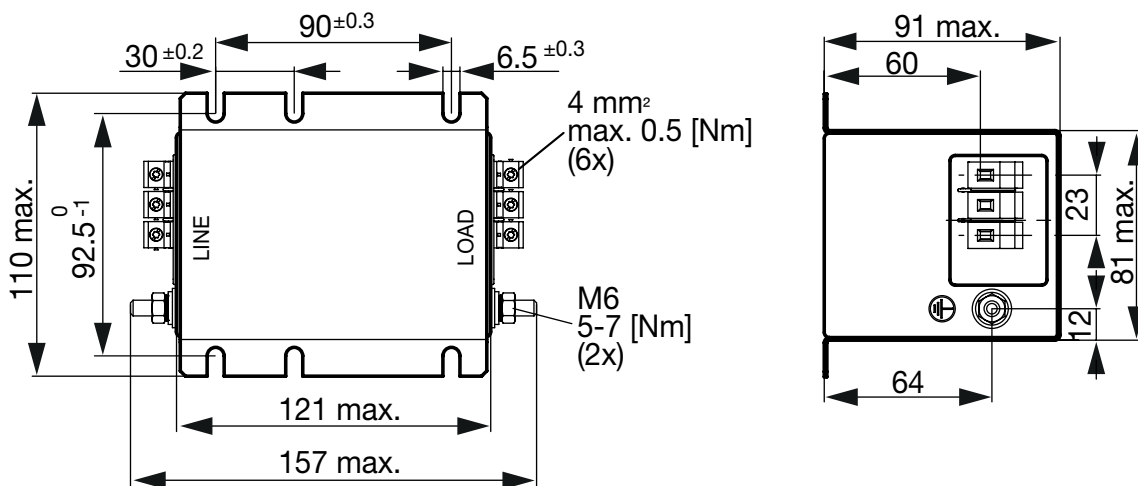

Case 5A-10

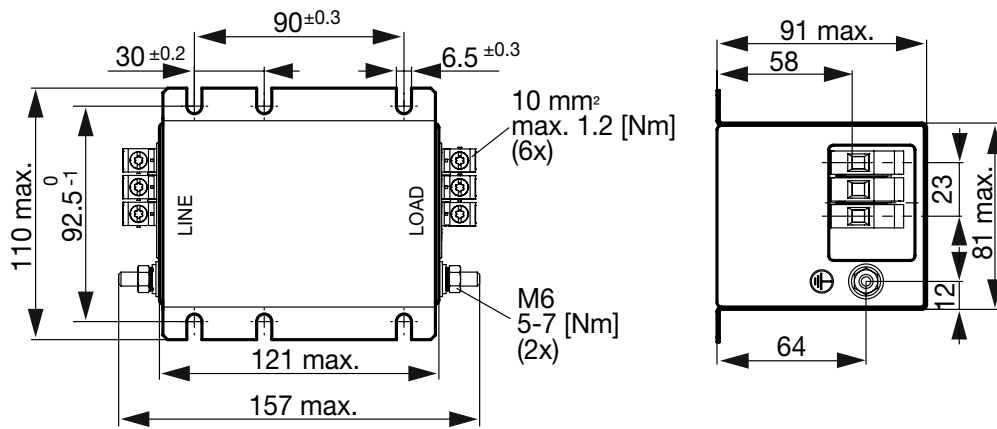

Case 5B-10

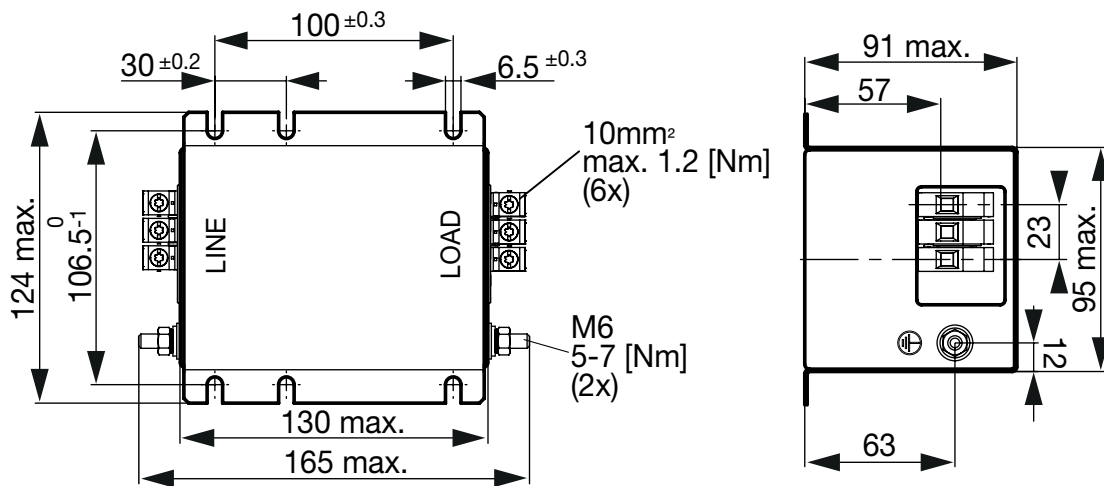

Case 5B-16

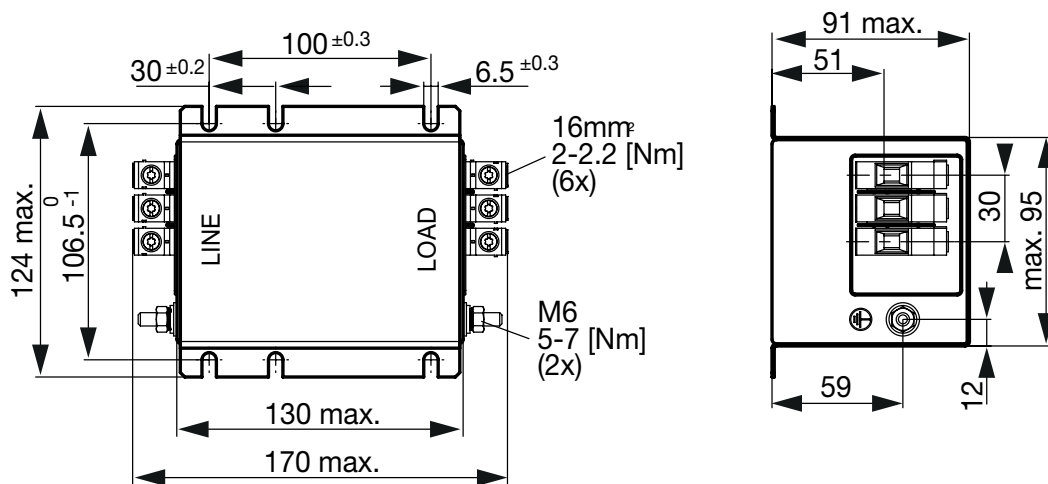

Case 4C-25

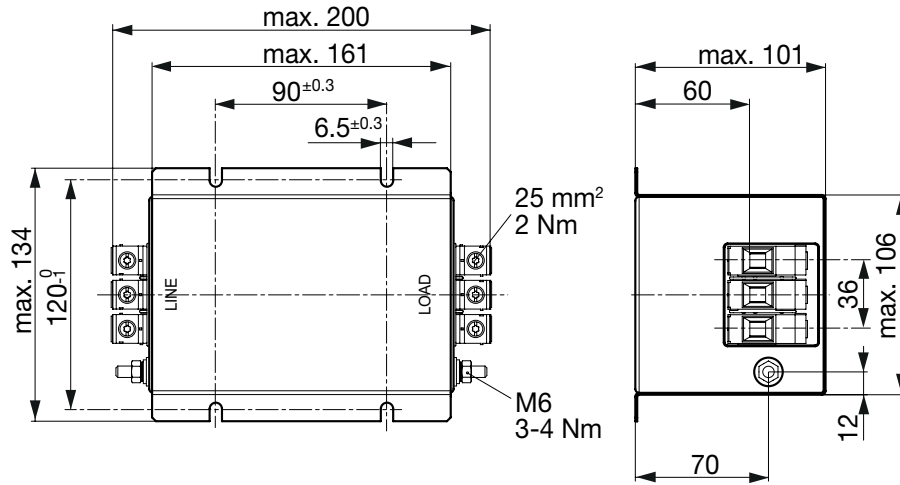

Case 4C-50

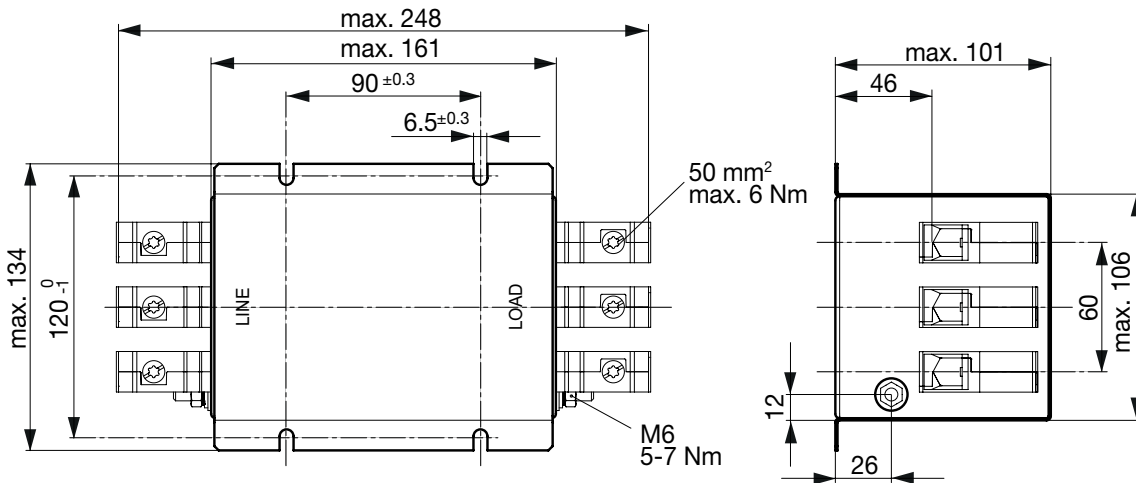

Case 4D

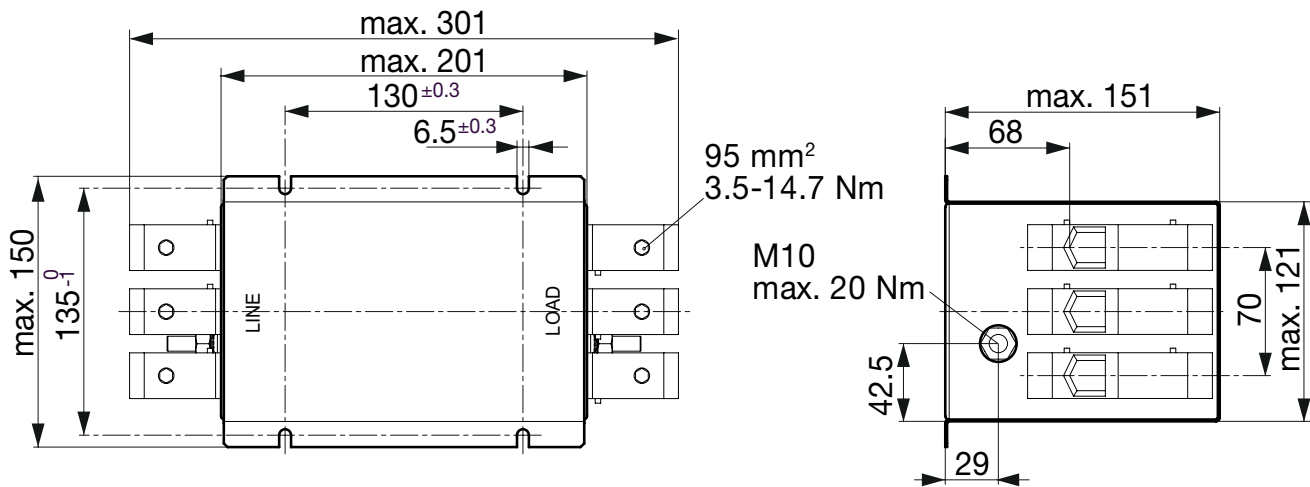

Diagrams

Industrial version

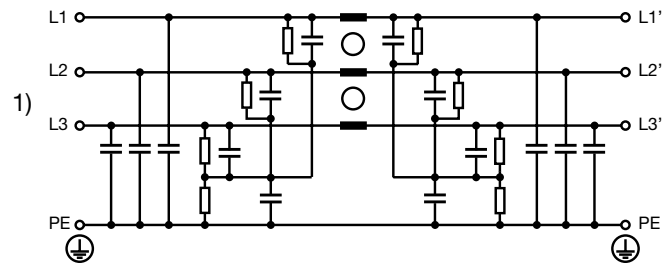

1) Line

Low leakage current version

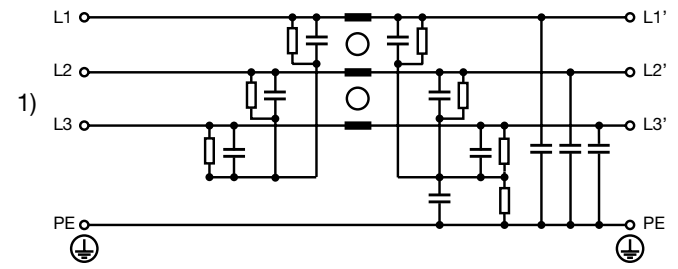

1) Line

Attenuation Loss

--- 50Ω differential mode    \_\_\_\_ 50Ω common mode

Industrial version

16 A

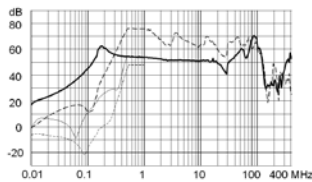

25 A

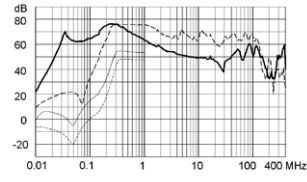

36 A

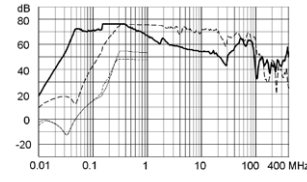

50 A

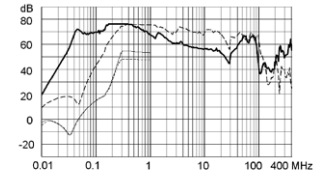

64 A

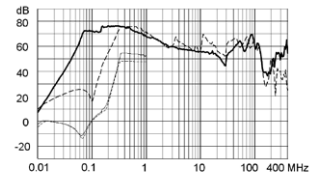

80 A

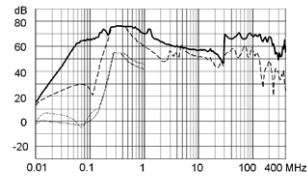

110 A

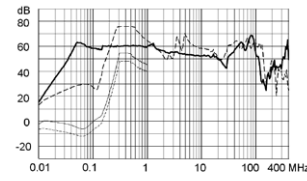

180 A

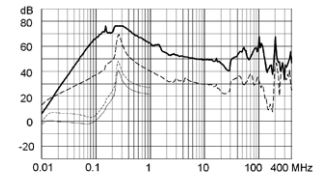

230 A

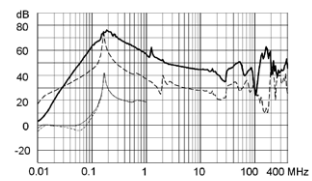

Low leakage current version

16 A

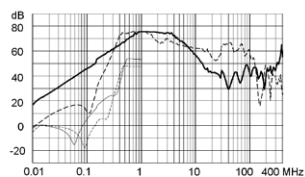

25 A

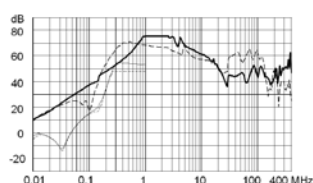

36 A

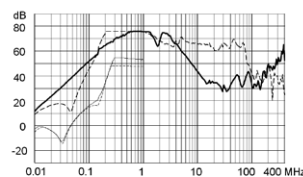

50 A

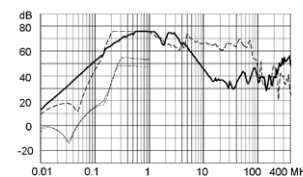

64 A

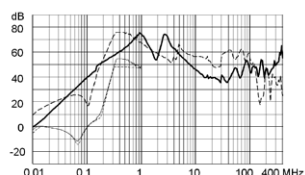

Variants

Rated Current @ Ta 50°C [A]	Filter Type	Machine Safety	Power Dissipation [W]	Contact Resistance [mΩ]	Leakage Current [mA] @ 440V, 60Hz 1)	Weight [kg]	Screw clamps [mm2] 2)	Housing	Order Number
16	Industrial version	●	1.6	6.2	10.5	0.9kg	4	5A-4	3-138-283
25	Industrial version	●	1.9	3	10.7	1.1 kg	10	5A-10	3-138-284
36	Industrial version	●	3.2	2.4	10.7	1.2kg	10	5B-10	3-138-285
50	Industrial version	●	6	2.4	11.4	1.2kg	10	5B-10	3-138-286
64	Industrial version	●	3.7	0.9	11.4	1.3kg	16	5B-16	3-138-287
80	Industrial version	●	4	0.6	12.2	1.4kg	25	4C-25	3-138-288
110	Industrial version	●	4.9	0.4	12.2	2.5kg	50	4C-50	3-138-289
180	Industrial version	●	4.4	0.1	12.2	3 kg	95	4D	3-138-290
230	Industrial version	●	5.8	0.1	13.1	4 kg	95	4D	3-138-291
16	Low leakage current version	●	1.6	6.2	1.4	0.9kg	4	5A-4	3-138-292
25	Low leakage current version	●	1.9	3	3	1.1 kg	10	5A-10	3-138-293
36	Low leakage current version	●	3.2	2.4	3	1.2kg	10	5B-10	3-138-294
50	Low leakage current version	●	6	2.4	3	1.2kg	10	5B-10	3-138-296
64	Low leakage current version	●	3.7	0.9	3	1.3kg	16	5B-16	3-138-297
16	Industrial version		1.6	6.2	10.5	0.9kg	4	5A-4	3-104-580
25	Industrial version		1.9	3	10.7	1.1 kg	10	5A-10	3-104-581
36	Industrial version		3.2	2.4	10.7	1.2kg	10	5B-10	3-104-582
50	Industrial version		6	2.4	11.4	1.2kg	10	5B-10	3-104-583
64	Industrial version		3.7	0.9	11.4	1.3kg	16	5B-16	3-104-584
80	Industrial version		4	0.6	12.2	1.4kg	25	4C-25	3-104-585
110	Industrial version		4.9	0.4	12.2	2.5kg	50	4C-50	3-104-586
180	Industrial version		4.4	0.1	12.2	3kg	95	4D	3-104-587
230	Industrial version		5.8	0.1	13.1	4kg	95	4D	3-104-588
16	Low leakage current version		1.6	6.2	1.4	0.9kg	4	5A-4	3-104-862
25	Low leakage current version		1.9	3	3	1.1 kg	10	5A-10	3-104-841
36	Low leakage current version		3.2	2.4	3	1.2kg	10	5B-10	3-104-872

Rated Current @ Ta 50°C [A]	Filter Type	Machine Safety	Power Dissipation [W]	Contact Resistance [mΩ]	Leakage Current [mA] @ 440V, 60Hz 1)	Weight [kg]	Screw clamps [mm <sup>2</sup> ] 2)	Housing	Order Number
50	Low leakage current version		6	2.4	3	1.2 kg	10	5B-10	3-104-873
64	Low leakage current version		3.7	0.9	3	1.3 kg	16	5B-16	3-104-874

Availability for all products can be searched real-time: <https://www.schurter.com/en/info-center/support-tools/stock-check-distributors>

1) Leakage current according IEC 60939-1

2) Maximum conductor cross section (wire gauge) to be used; a comparative table for AWG and mm<sup>2</sup> values can be found in the general product information <https://www.schurter.com/en/FAQ#10>

**Packaging unit** 1 Pcs